



**Operating Manual**  
**Chillgard 5000 Refrigerant Monitor**  
**Chillgard 5000 Ammonia Monitor**



Order No.: 10178535/02  
CR 800000027642

 **WARNING!**

Read this manual carefully before using the device. The device will perform as designed only if it is used and maintained in accordance with the manufacturer's instructions. Otherwise, it could fail to perform as designed and persons who rely on this device for their safety could sustain serious personal injury or death.

---

The warranties made by MSA with respect to the product are voided if the product is not installed and used in accordance with the instructions in this manual. Please protect yourself and your employees by following the instructions.

Please read and observe the WARNINGS and CAUTIONS inside.

 **WARNING!**

Make sure any personnel who will be installing, using, or maintaining this device have access to the user manual. If electronic access to the user manual (through the supplied Chillgard 5000 CD or MSA website) is not possible, print a copy of the manual and keep it in an accessible location near the device.

Failure to obey the following guidelines and/or incorrect installation, operation, servicing, or maintenance of the device can cause incorrect operation of the device. Personnel who rely on this product for their safety can sustain serious personal injury or death.

---



*The Safety Company*

1000 Cranberry Woods Drive  
Cranberry Township, PA 16066  
USA  
Phone 1-800-MSA-2222  
Fax 1-800-967-0398

For your local MSA contacts please go to our website [www.MSAafety.com](http://www.MSAafety.com)

## Contents

<b>1</b>	<b>MSA Permanent Instrument Warranty</b>	<b>6</b>
1.1	Warranty	6
1.2	Exclusive Remedy	6
1.3	Exclusion of Consequential Damage	6
1.4	Liability Information	6
<b>2</b>	<b>Warnings and Cautions</b>	<b>7</b>
<b>3</b>	<b>Description</b>	<b>9</b>
3.1	Identifying Your Unit	10
3.2	Visible Alarming Devices	13
3.2.1	Touchscreen Display	13
3.2.2	Optional Strobe	13
3.3	Audible Alarming Devices	13
3.3.1	Internal Horn	13
3.3.2	Optional External Horn	13
3.4	Optional External Alarm Activation and Silencing Stations	13
3.5	Communications	14
3.5.1	Digital Communication	14
3.5.2	Analog Communication	14
<b>4</b>	<b>Installation</b>	<b>16</b>
4.1	Warnings and Cautions	16
4.2	Receiving, Unpacking, and Inspecting	16
4.3	Mounting Guidelines	17
4.4	Sample and Exhaust Lines	19
4.4.1	Tubing Material	19
4.4.2	Routing and Placement	20
4.4.3	End-of-Line Filters	21
4.4.4	Connections	21
4.4.5	Exhaust Venting or R-Gases	22
4.5	Wiring and Grounding	22
4.6	Electrical Power Supply Requirements	24
4.7	Relay Outputs	25
4.8	Remote Display	25
<b>5</b>	<b>Initial Setup</b>	<b>26</b>
5.1	Language/Date & Time/Password	26
5.2	Point Configuration	29
5.3	Gas Configuration	30
5.3.1	Configuration for Refrigerant Monitor	30
5.3.2	Configuration for Ammonia Monitor	33
5.4	Relay Configuration	35
5.5	Communications Output	37

<b>6</b>	<b>Calibration</b> .....	<b>39</b>
6.1	Initial Setup .....	40
6.2	Routine Operation .....	41
6.2.1	Starting Calibration .....	41
6.2.2	Stopping Calibration .....	42
6.3	Zero Gas Calibration .....	43
6.4	Span Gas Calibration .....	44
6.4.1	Span Gas Calibration Refrigerant Monitor .....	44
6.4.2	Span Gas Calibration Ammonia Monitor .....	46
6.5	Unsuccessful Calibrations .....	47
<b>7</b>	<b>Routine Operation</b> .....	<b>48</b>
7.1	Dashboard Overview .....	48
7.2	Point Details .....	49
7.3	Point Hold .....	49
7.3.1	Automatic Point Hold .....	49
7.3.2	Manual Point Hold .....	49
7.4	Predictive Warnings .....	50
7.5	Cautions, Warnings, and Alarms .....	51
7.5.1	Non-Latching Events .....	51
7.5.2	Latching Events .....	51
7.6	Faults .....	52
7.6.1	Noncritical Faults .....	53
7.6.2	Critical Faults .....	54
7.7	Event Log .....	54
7.7.1	All .....	55
7.7.2	Alarms .....	55
7.7.3	Faults .....	56
7.7.4	Calibration .....	56
7.8	Edit Settings .....	57
7.8.1	Preferences .....	57
7.8.2	Gas Configuration .....	58
7.8.3	Point Configuration .....	59
7.8.4	Relay Configuration .....	62
7.8.5	Communications Output .....	63
7.8.6	About .....	64
<b>8</b>	<b>Diagnostics</b> .....	<b>65</b>
8.1	Flow Diagnostics .....	65
8.2	Sensor Performance .....	67
8.3	Pump Performance .....	69
8.4	Errors .....	70
<b>9</b>	<b>Maintenance</b> .....	<b>71</b>
9.1	Scheduled Maintenance .....	71
9.1.1	Examine and Replace End-of-Line Filters .....	71
9.1.2	Examine and Replace Internal Inline Filters .....	72
9.1.3	Replace Fuses .....	73



<b>10</b>	<b>Cleaning</b> .....	<b>74</b>
10.1	Touchscreen Display .....	74
10.2	Enclosure .....	74
<b>11</b>	<b>Technical Data</b> .....	<b>75</b>
11.1	Technical Specifications / Equipment Ratings .....	75
11.2	Gas Reading Accuracy .....	76
<b>12</b>	<b>Troubleshooting Guidelines</b> .....	<b>77</b>
<b>13</b>	<b>Ordering Information</b> .....	<b>78</b>
13.1	Replacement Parts .....	78
13.1.1	Replacement Parts .....	79
13.1.2	Accessories .....	79
13.1.3	Installation and Calibration .....	80
<b>14</b>	<b>Appendix A: Start-up Check List</b> .....	<b>81</b>
<b>15</b>	<b>Appendix B: Installation of Optional Equipment</b> .....	<b>82</b>
15.1	Strobe .....	82
15.2	External Horn .....	83
15.3	External Alarm Activation Station .....	84
15.4	External Alarm Silencing Station .....	84
<b>16</b>	<b>Appendix C: Default Settings</b> .....	<b>85</b>
16.1	Alarm Setpoints .....	85
16.2	Relays .....	85
16.3	Output .....	85
<b>17</b>	<b>Appendix D: Modbus Holding Registers</b> .....	<b>86</b>
17.1	Chillgard 5000 - Modbus RTU (Holding Registers) .....	86
17.2	RESET Button Actions .....	89
17.3	Unit Status Flags .....	90
17.4	Channel Status Flags .....	90
17.5	Gas Types .....	91
<b>18</b>	<b>Appendix E: BACnet Objects</b> .....	<b>92</b>
18.1	Chillgard 5000 - BACnet .....	92
18.2	RESET Button Actions .....	96
18.3	Unit Status Flags .....	96
18.4	Channel Status Flags .....	96
18.5	Gas Types .....	97



## 1 MSA Permanent Instrument Warranty

### 1.1 Warranty

MSA, the Safety Company warrants that these products will be free from mechanical defect or faulty workmanship for a period of two (2) years from the date of delivery, provided it is maintained and used in accordance with MSA's instructions and/or recommendations.

This warranty does not apply to expendable or consumable parts whose normal life expectancy is less than one (1) year, such as, but not limited to, nonrechargeable batteries, filament units, filter, lamps, fuses, etc. MSA shall be released from all obligations under this warranty in the event that repairs or modifications are made by persons other than its own or authorized service personnel or if the warranty claim results from physical abuse or misuse of the product. No agent, employee, or representative of MSA has any authority to bind MSA to any affirmation, representation, or warranty concerning the goods sold under this contract. MSA makes no warranty concerning components or accessories not manufactured by MSA, but will pass on to the Purchaser all warranties of manufacturers of such components.

**THIS WARRANTY IS IN LIEU OF ALL OTHER WARRANTIES, EXPRESSED, IMPLIED, OR STATUTORY, AND IS STRICTLY LIMITED TO THE TERMS HEREOF. SELLER SPECIFICALLY DISCLAIMS ANY WARRANTY OF MERCHANTABILITY OR OF FITNESS FOR A PARTICULAR PURPOSE.**

### 1.2 Exclusive Remedy

It is expressly agreed that the Purchaser's sole and exclusive remedy for breach of the above warranty, for any tortious conduct of the Seller, or for any other cause of action, shall be the repair and/or replacement at the Seller's option of any equipment or parts thereof, which after examination by the Seller is proven to be defective. Replacement equipment and/or parts will be provided at no cost to the Purchaser, F.O.B. Seller's Plant. Failure of the Seller to successfully repair any nonconforming product shall not cause the remedy established hereby to fail of its essential purpose.

### 1.3 Exclusion of Consequential Damage

The Purchaser specifically understands and agrees that under no circumstances will the Seller be liable to the Purchaser for economic, special, incidental, or consequential damages or losses of any kind whatsoever, including but not limited to, loss of anticipated profits and any other loss caused by reason of nonoperation of the goods. This exclusion is applicable to claims for breach of warranty, tortious conduct, or any other cause of action against the Seller.

### 1.4 Liability Information

MSA accepts no liability in cases where the device has been used inappropriately or not as intended. The selection and use of the device are the exclusive responsibility of the individual operator. Product liability claims, warranties, and guarantees made by MSA with respect to the device are voided if the device is not operated, serviced, and/or maintained in accordance with the instructions in this manual.

The warranties made by MSA with respect to the product are voided if the product is not used and serviced in accordance with the instructions in this manual. Please protect yourself and others by following them. We encourage our customers to write or call regarding this equipment prior to use or for any additional information relative to use or repairs.

## 2 Warnings and Cautions

The Chillgard 5000, hereafter also referred to as "the device", is a gas monitor intended for indoor use in mechanical equipment rooms or commercial spaces where refrigerant equipment, such as centrifugal chillers, is used. The device is specified to support compliance with federal, state, and local safety codes that govern emissions.

### **WARNING!**

Install, operate, and maintain the device in strict accordance with its labels, cautions, warnings, instructions, and stated limitations.

For any maintenance procedure provided in this manual, use only genuine MSA replacement parts. Repair or alteration of the Chillgard 5000 system beyond the scope of these maintenance instructions or by anyone other than authorized MSA service personnel can cause incorrect operation of the device. For a list of approved parts and how to order them, refer to Section 13 "Ordering Information".

The device is intended for indoor use only. Do not use the device for outdoor applications.

Never operate the device without a connection to positive ground. Failure to connect the device to positive ground can result in electrical shock. Electrical shock can cause damage to the device and injury to personnel.

Make sure the device is not located in areas that contain a flammable mixture of gas and air. Otherwise, an explosion can occur.

The device is not intrinsically safe. Do not use the device in areas classified as hazardous or locations where explosive concentrations of combustible gases or vapors can occur.

Failure to follow these warnings can result in serious bodily injury or death.

---

**⚠ WARNING!**

Make sure the device is installed in a clean, dry area that is protected from vibration, including but not limited to a chiller, and heat sources.

Do not paint the device. Do not paint near any of the sample line inlets. If painting is done near the device, make sure that paint is not deposited on the sample inlet fittings. Paint deposits can prevent correct operation of the device.

Make sure the sample inlet lines to the device are clean and noncondensing.

Avoid any installation where condensation can collect. Condensation can clog or block sample lines, which will prevent the device from receiving new or fresh gas samples in the area being monitored.

Install and maintain end-of-line filters in all sample inlet lines. Refer to Section 4.4.3 "End-of-Line Filters".

The only absolute method of ensuring correct overall operation of a gas detection instrument is to do a check with a known concentration of the gas for which it has been calibrated. Do a calibration check as part of the installation and initial setup. Refer to Section 6.1 "Initial Setup". Do routine calibration checks thereafter. Refer to Section 6.2 "Routine Operation".

Install a circuit breaker for the incoming power connections of the device. Put the circuit breaker in a location that is easy to access and near the device. Clearly mark the circuit breaker as the disconnecting unit for the device.

Properly vent the exhaust of the Chillgard 5000 system to a safe area. Improper venting of the exhaust can cause serious personal injury or death. Refer to Section 4.4.5 "Exhaust Venting or R-Gases".

To prevent unauthorized or untrained personnel from opening the device enclosure, install a locking mechanism through the metal loop on either latch on the left side of the device (Fig. 2).

Perform periodic leak tests on all sample lines.

Do not exceed the relay contact rating listed in Section 11.1 "Technical Specifications / Equipment Ratings". Otherwise relay operation may fail.

Failure to follow these warnings can result in serious bodily injury or death.

---



### 3 Description

The Chillgard 5000 provides continuous monitoring of refrigerant gas levels for up to 16 points in nonhazardous areas. With the ability to read down to 1 ppm on the Refrigerant monitor and 10 ppm on the ammonia monitor, the device provides a response to a refrigerant leak, supporting the safety of personnel and the environment, and equipment efficiency. The device uses patented Photoacoustic Infrared technology to allow the accurate measurement of refrigerant gases with minimum interference from other vapors. The device monitors refrigerant gases up to 1000 ppm with an ability to maintain a gas list through an internal refrigerant library.

The Chillgard 5000 minimizes unnecessary maintenance costs associated with calibration and sensors by utilizing a centralized sample draw system. The device is factory calibrated for six specific refrigerants, with the flexibility to adjust the gas of interest in the field.

The device offers three levels of alarm—caution, warning, and alarm—that are all configurable through the intuitive touchscreen display. Fault and service notifications provide alerts when servicing is necessary. Audible and visual indications such as horns and strobes provide alerts about refrigerant leaks.

Digital communications can be transmitted using the Modbus remote terminal unit (RTU) or BACnet™ master/slave token passing (MS/TP) protocol. Analog communications can be transmitted using a 4–20 mA or 0–10 Vdc current loop.

The Chillgard 5000 requires minimal maintenance and incorporates predictive diagnostics that continuously check key detector components to ensure proper operation. When the device is installed, operated, and maintained according to MSA's recommendations, it provides reliable protection and long-term stability.

The Chillgard 5000 Remote Display provides entryway signaling for environments in which the Chillgard 5000 is installed. The Chillgard 5000 Remote Display fulfills the requirements set by the ASHRAE 15 standard.

### 3.1 Identifying Your Unit

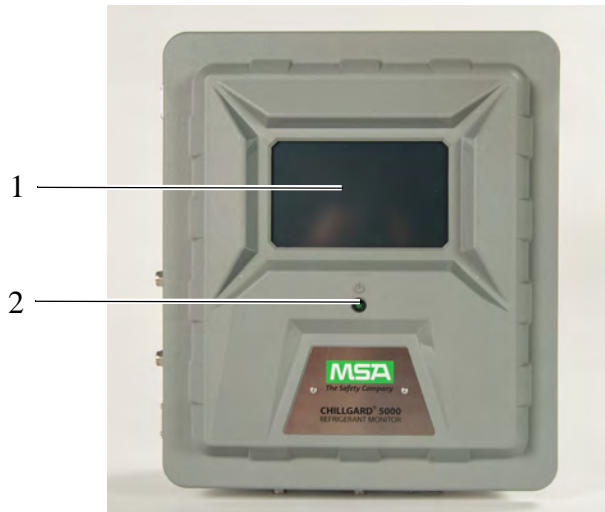

Fig. 1 Front of device

- 1 7" resistive touchscreen user interface
- 2 Power indicator

**NOTE:** Optional strobe not shown.



Fig. 2 Back of device

- 1 Mounting locations (10" x 14 5/8")

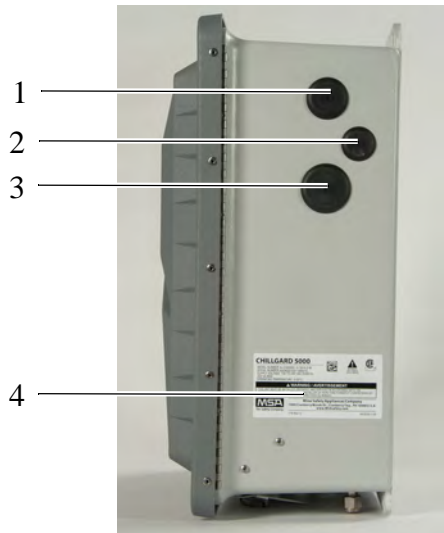

Fig. 3 Right side of device

- 1 AC power wiring cutout
- 2 Protective earth grounding cutout (optional)
- 3 Relay wiring cutout
- 4 Approval and unit identification label

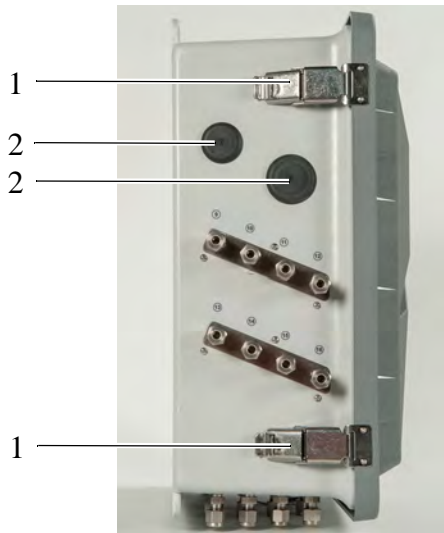

Fig. 4 Left side of device

- 1 Latches (lockable with padlock)
- 2 Signal wiring cutouts

US



Fig. 5 Bottom of device

- 1 Sample line with protection cover
- 2 Internal alarm sounder
- 3 Calibration port
- 4 IP rated vent
- 5 Exhaust port (do not block) with protection cap

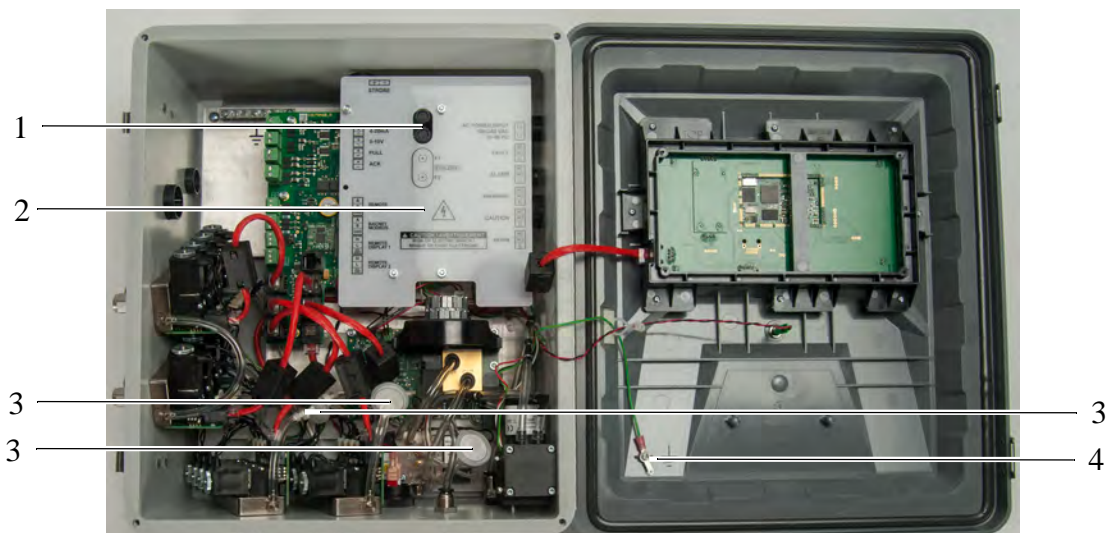

Fig. 6 Internal touchpoints

- 1 Fuses
- 2 AC wiring cover
- 3 Internal filters
- 4 ESD tie-off location

**⚠ WARNING!**

Make sure the AC wiring cover is within the delivery and not damaged.  
 Failure to follow these warnings can result in serious bodily injury or death.



## 3.2 Visible Alarming Devices

The device provides visible alarm indicators through the touchscreen display and optional strobe.

### 3.2.1 Touchscreen Display

After the initial setup configuration, the touchscreen display shows a dashboard with the main function buttons and tiles for the points that are enabled.

Notifications for all predictive warnings, alarms, and faults show on the dashboard.

### 3.2.2 Optional Strobe

The optional strobe provides a user-configurable visual indication of a gas leak.

For a list of approved parts and how to order them, refer to Section 13 "Ordering Information".

For installation instructions, refer to Section 15 "Appendix B: Installation of Optional Equipment".

## 3.3 Audible Alarming Devices

The device provides audible alarm indicators through the internal alarm and optional external horn.

### 3.3.1 Internal Horn

A horn inside the device provides an audible indicator of a gas leak. The level of sound output from the internal horn is adjustable. To adjust the level of sound output, turn the sounder clockwise or counterclockwise.

### 3.3.2 Optional External Horn

An optional external horn can be mounted in a location away from the device to provide an audible indicator of a gas leak.

For a list of approved parts and how to order them, refer to Section 13 "Ordering Information".

For installation instructions, refer to Section 15 "Appendix B: Installation of Optional Equipment".

## 3.4 Optional External Alarm Activation and Silencing Stations

The device supports optional external stations for the activation and silencing of audible alarms.

Normally closed alarm activation and silencing switches can be wired in a single loop with a total maximum loop length of 2500 ft (762 m).

For a list of approved parts and how to order them, refer to Section 13 "Ordering Information".

For installation instructions, refer to Section 15 "Appendix B: Installation of Optional Equipment".

### 3.5 Communications

The device has both digital and analog outputs for use with external controllers or building management systems.

#### 3.5.1 Digital Communication

The device is capable of Modbus RTU or BACnet MS/TP outputs. For setup instructions, refer to Section 5.5 "Communications Output".

For a list of the registers that are available for exchange with the Modbus controller, refer to Section 17 "Appendix D: Modbus Holding Registers".

For a list of the BACnet Objects that are available for exchange with the BACnet controller, refer to Section 18 "Appendix E: BACnet Objects".

#### 3.5.2 Analog Communication

The device is capable of the following types of analog outputs:

- 4–20 mA, isolated, current sourcing
- 0–10 Vdc for gas sample point identification

##### Scale Analog Output: 4–20 mA

Full scale is 1000 ppm.

Normal gas readings are at 4–20 mA. The reading is proportional to the detected gas concentration.

For the factory default of 100% full scale setting (0.016 mA = 1 ppm):

Output (mA)	Gas Concentration (ppm)
4	0
5	63
6	125
7	188
8	250
9	313
10	375
11	438
12	500
13	563
14	625
15	688
16	750
17	813
18	875
19	937
20	1000

**Analog Output Settings**

Warm-up	Default = 3.5 mA User adjustable between 0 and 3.75 mA
Calibration (nonconfigurable)	3.0 mA
Fault	Default = 2.0 mA User adjustable between 0.5 and 3.75 mA
Device over range (nonconfigurable)	21 mA

**0–10 Vdc**

The voltage output can be used to identify any active gas sample line.

Sample Line	Vdc 4 or 8 pt system	Vdc 16 pt system
1	1	1.0
2	2	1.5
3	3	2.0
4	4	2.5
5	5	3.0
6	6	3.5
7	7	4.0
8	8	4.5
9	-	5.0
10	-	5.5
11	-	6.0
12	-	6.5
13	-	7.0
14	-	7.5
15	-	8.0
16	-	8.5

While the device is in calibration mode, the output is 10 Vdc.

## 4 Installation

### 4.1 Warnings and Cautions

#### **WARNING!**

The device is intended for indoor use only. Do not use the device for outdoor applications.

A qualified electrician must do electrical wiring.

All wiring must comply with all applicable local electrical safety codes.

To prevent electrostatic discharge (ESD), connect an ESD wrist strap to the ESD connection point inside the device enclosure before doing work inside the enclosure. ESD can cause damage to the device.

Do not touch the electronic circuit boards.

Do not install or operate a device that has damage.

Disconnect ac power before opening the device enclosure. Failure to do so can result in electrical shock. Electrical shock can cause damage to the device and injury to personnel.

Never operate the device without a protective ground. Operating the device without a protective ground can result in electrical shock. Electrical shock can cause damage to the device and injury to personnel.

The device is not intrinsically safe. Do not use the device in areas classified as hazardous or locations where explosive concentrations of combustible gases or vapors can occur.

Ensure that the device and its sample lines are not located in areas that contain a flammable mixture of gas and air. Otherwise, an explosion can occur.

Failure to follow these warnings can result in serious bodily injury or death.

---

### 4.2 Receiving, Unpacking, and Inspecting

- (1) Upon receipt of the device, inspect the shipping container for signs of damage. Report any damage to the carrier and record the information on the delivery receipt.
- (2) Carefully remove the device from its shipping container to avoid causing damage to sensitive electrical components. If damage has occurred, file the appropriate claim with the shipping carrier immediately.
- (3) Review all contents of the shipping container to make sure all of the following components are included:
  - a) Device
  - b) Instruction manual CD
  - c) Protective foam
- (4) Notify MSA of any shortages immediately.
- (5) Keep the original packaging in case it is necessary to return the device for service.
- (6) Release the two latches on the left side of the device.
- (7) Open the enclosure.
- (8) Carefully inspect the internal components and assemblies for damage or shortages. If damage has occurred, file the appropriate claim with the shipping carrier immediately.



- (9) Before installation and use, keep the device in a dry, secure place in the original shipping container.

### 4.3 Mounting Guidelines

Do not mount the device directly to chiller, piping, or piping supports.

Mount the device:

- In a location that is easy to access and visible to personnel before they go into the area being monitored.
- To a rigid surface that does not have vibration or mechanical shock.
- In a vertical position.
- Approximately 5 ft (1.5 m) above the ground (Fig. 7, Fig. 9).
- For ammonia, mount the lines near the ceiling (Fig. 8).
- With at least 3 in. (7.62 cm) of clearance around all sides for proper ventilation, calibration, and servicing. Make sure there is adequate space to connect the external wiring and sample line piping (Fig. 9).
- With the appropriate hardware. Make sure the hardware is suitable for the mounting surface and can withstand 70 lb (31,7 kg) without loosening or causing damage to the hardware or mounting surface. Use all four mounting holes provided on the device (Fig. 10).
- Away from exposure to direct solar heating and other excessive heat sources.
- Away from wet or damp conditions.
- Away from areas that are dirty or exposed to oils or chemicals.

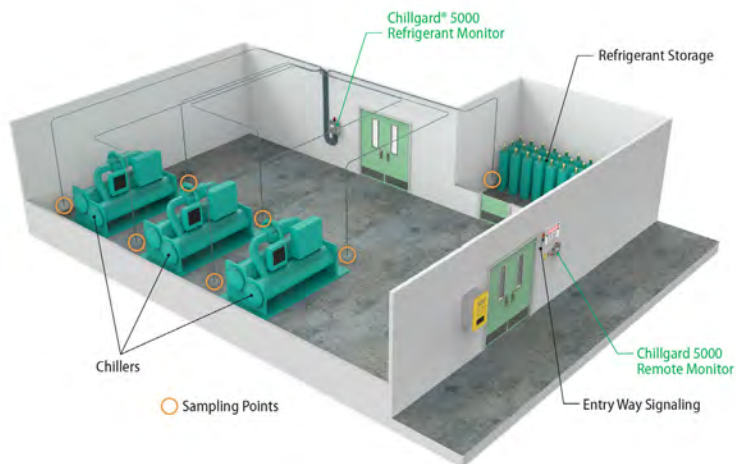

Fig. 7 Mounting location for refrigerants

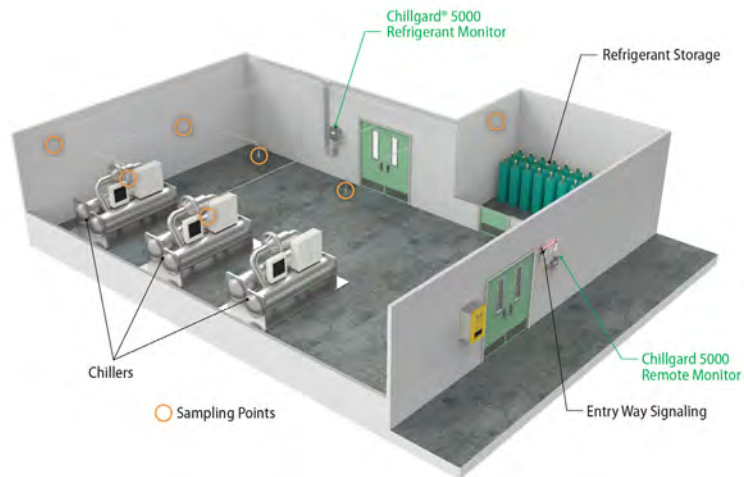

Fig. 8 Mounting location (Ammonia)

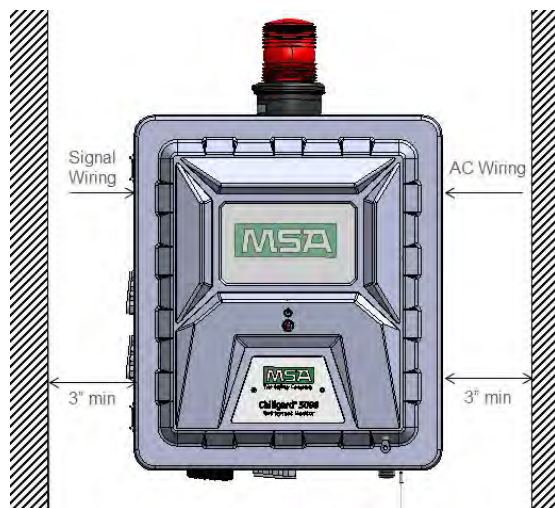

Fig. 9 Front of device



Fig. 10 Rear of device

US

## 4.4 Sample and Exhaust Lines

### 4.4.1 Tubing Material

The device can use hard and soft tubing. The following are acceptable tubing types:

---

#### US English System

---

¼ in. OD x 1/8 in. inside diameter (ID) Polyurethane tubing (ether based)

---

¼ in. OD x 3/16 in. ID Polyurethane tubing (ether based)

---

¼ in. OD Copper tubing

---

¼ in. OD Stainless steel tubing

---

NH<sub>3</sub> tubing: ¼ in. OD SS or 1/8 in. inside FEP-lined tubing only

---

---

#### SI Units

---

6 mm OD x 4 mm ID Polyurethane tubing (ether based)

---

6 mm OD Copper tubing

---

6 mm OD Stainless steel tubing

---

NH<sub>3</sub>: 6 mm OD x 4 mm ID FEP-lined; 6 mm OD Stainless steel only

---

#### **NOTICE**

Use the appropriate tools to give a clean, smooth end to the tubing when it is cut.

---

#### 4.4.2 Routing and Placement

MSA recommends the use of at least two gas-monitoring points per chiller for sufficient detection monitoring. Due to installation and application variations, each system must be analyzed individually.

Do a smoke test of the mechanical room to determine the flow pattern and allow for optimal placement of the sample lines. Ventilation smoke tubes for this use are available from MSA (P/N 458480). For a list of approved parts and how to order them, refer to Section 13 "Ordering Information".

Keep the total line length of a point, including the sample line and exhaust line, at less than 1200 ft (366 m). Keep lines as short as possible to minimize the transport time of the device.

Transport Time				
Line Length		4 pts	8 pts	16 pts
ft	m			
0	0	19 s	19 s	19 s
50	15,24	19 s	19 s	19 s
100	30,48	19 s	19 s	19 s
150	45,72	19 s	19 s	19 s
200	60,96	19 s	19 s	19 s
250	76,2	19 s	19 s	19 s
300	91,44	1 m 35 s	2 m 51 s	5 m 23 s
350	106,68	1 m 35 s	2 m 51 s	5 m 23 s
400	121,92	2 m 51 s	5 m 23 s	10 m 27 s
450	137,16	2 m 51 s	5 m 23 s	10 m 27 s
500	152,4	2 m 51 s	5 m 23 s	10 m 27 s

\* Transport time is similar for all tubing configurations.

Typically, refrigerants collect near the floor. Install the sample points 12–18 in. (30–46 cm) above the floor.

Ammonia gas tends to rise to the ceiling due to its being lighter than air. MSA recommends placing sample points at potential leak areas.

For installations where water condensation in the sample lines is likely, MSA recommends installing a water trap filter such as a Parker P/N F504-01AHX67 or equivalent.

To confirm sample lines are labeled and routed appropriately, apply calibration gas to the end of the line and confirm device response.

#### 4.4.3 End-of-Line Filters

##### **⚠ WARNING!**

Failure to use and maintain end-of-line filters can cause inaccurate readings and damage to internal components, and make additional servicing necessary.

Failure to follow these warnings can result in serious bodily injury or death.

Install an end-of-line filter (MSA P/N 711561) in each sample line to decrease contaminants in the sample lines and device. For the ammonia unit, install an individual end-of-line filter (P/N 711562).



Fig. 11 End-of-line filter

Do the following procedure to install end-of-line filters:

- (1) Remove the new end-of-line filter from the bag.
- (2) Slide the end of the end-of-line filter with flexible tubing onto the sample line tubing. Make sure the arrow on the body of the filter (Fig. 11) points in the direction of air flow into the sample line.

Examine and replace the end-of-line filters at regular intervals. The appropriate interval for replacement is determined by the environment of the installation.

For a list of approved parts and how to order them, refer to Section 13 "Ordering Information".

#### 4.4.4 Connections

##### **⚠ WARNING!**

Install tubing with large enough bend radii to prevent kinking or pinching. Kinking or pinching of the tubing can result in insufficient monitoring of an area.

Before connecting tubing to the device, clean all tubing with compressed air or nitrogen to remove debris.

Failure to follow these warnings can result in serious bodily injury or death.

The device has Swagelok® compression fittings for connections to the sample and exhaust lines. These fittings accept the hard and soft tubing specified in Section 4.4.1 "Tubing Material".

Do the following procedure to connect the sample and exhaust lines:

- (1) Remove the cap from the compression fitting.
- (2) Insert the tubing fully into the compression fitting and against the shoulder.
- (3) Turn the nut until it is finger-tight on the tubing.
- (4) Mark the nut at the 6 o'clock position.
- (5) While holding the body of the fitting steady, tighten the nut 1 ¼ turns to the 9 o'clock position.

#### 4.4.5 Exhaust Venting or R-Gases

The use of exhaust tubing reduces pump noise from the device.

Make sure to vent the exhaust of the device to the outside atmosphere (preferred) or a safe area.

Do not use inline or end-of-line filters in the exhaust line.

Route the exhaust line so venting occurs to the outside atmosphere where personnel will not be present. Make sure to protect the end of the exhaust tube from elements such as water, dirt, snow, ice, and insects, which can cause clogs and prevent efficient venting.

If exhaust venting occurs indoors, make sure to route the exhaust line to:

- An area that is not monitored for refrigerant gases
- An area away from personnel

#### **WARNING!**

Make sure to remove the cap from the exhaust port before operating the device. Failure to do so will create back pressure that can result in inaccurate readings and damage to internal components.

Properly vent the exhaust of the Chillgard 5000 system to a safe area. Improper venting of the exhaust can cause serious personal injury or death.

Do not use indoor exhaust vents for ammonia.

Failure to follow these warnings can result in serious bodily injury or death.

---

#### 4.5 Wiring and Grounding

The Chillgard Wiring Diagram (Fig. 12) gives the details of the wiring requirements for the device.

#### **WARNING!**

Make sure the device chassis is connected to the earth ground at the ground bar.

Failure to follow these warnings can result in serious bodily injury or death.

---

#### **NOTICE**

Installations that require conformity to the European EMC and LDV regulation must have a connection between the Chillgard 5000 device and a nearby earth ground potential.

To achieve this connection, install a 10 AWG (6,00 mm<sup>2</sup>) or larger copper wire between the grounding lug terminal strip on the right side of the Chillgard 5000 device and the grounding point (protective earth). The wire length cannot be longer than 6 ft (2 m).

---

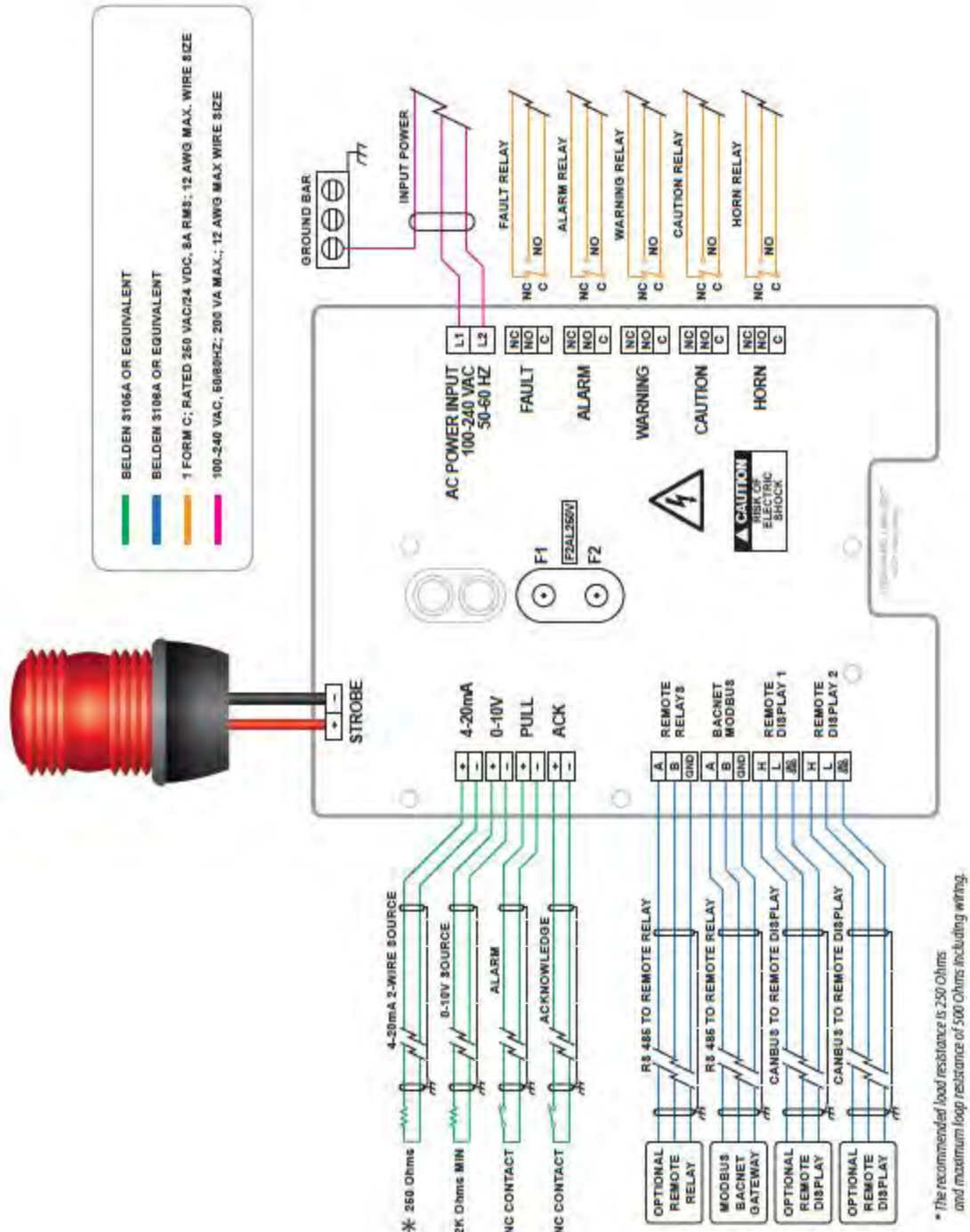

Fig. 12 Chillgard Wiring Diagram

## 4.6 Electrical Power Supply Requirements

### **WARNING!**

A qualified electrician must do electrical wiring.

Wiring must comply with all applicable local electrical safety codes.

Make sure that the copper conductors used to connect to supply mains meet all local electrical safety codes.

Never operate the device without a protective ground. Operating the device without a protective ground can result in electrical shock. Electrical shock can cause damage to the device and injury to personnel.

To prevent electrical shock, the circuit board cover must be in place when power is on. Electrical shock can cause serious personal injury or death.

To prevent electrostatic discharge (ESD), connect an ESD wrist strap to the ESD connection point inside the device enclosure before doing work inside the enclosure. ESD can cause damage to the device.

Do not touch the electronic circuit boards.

Failure to follow these warnings can result in serious bodily injury or death.

---

The device uses a power supply that accepts inputs of 100–240 Vac, 50/60 Hz, 200 VA maximum.

Make sure the device is connected directly to the ac power source through a dedicated circuit breaker.

Use an approved 3-conductor wire (minimum 16 AWG, 1,5 mm<sup>2</sup>), rated 300 Vac at 221°F (105°C), to complete the ac power connection.

Use only conduit hubs and hardware that are suitable for fiberglass enclosures.

Do the following procedure to connect electrical power:

- (1) Disconnect electrical power.
- (2) Install a circuit breaker for the incoming power connections of the device.
  - a) Put the circuit breaker in a location that is near the device and easy to access.
  - b) Clearly mark the circuit breaker as the disconnecting unit for the device.
- (3) If applicable, remove the locking mechanism.
- (4) Release the two latches on the left side of the device.
- (5) Open the enclosure.
- (6) Attach the ESD wrist strap to the ESD connection point inside the enclosure.
- (7) Use a ¼-in. hex driver to remove the 4 hex nuts on the circuit board cover.
- (8) Remove the circuit board cover.
- (9) Remove the ac power wiring hole plug.
- (10) Install conduit hubs that are suitable for fiberglass enclosures through the ac power wiring hole plug openings.
- (11) Put the ac power wiring through the conduit.



- (12) Connect the ac power wiring to the L1 (HOT) and L2 (NEUTRAL) input terminals. Make sure the connectors are seated securely.
- (13) Connect the ac power ground wire to the ground bar so the device chassis ground is connected to the earth ground.
- (14) Make sure the wiring is not touching the sensor assembly.
- (15) Install the circuit board cover.
- (16) Use a ¼-in. hex driver to install the 4 hex nuts on the circuit board cover.
- (17) Disconnect the ESD wrist strap from the ESD connection point inside the enclosure.
- (18) Close the enclosure.
- (19) Latch the two latches.
- (20) If applicable, attach the locking mechanism.
- (21) Supply electrical power to the device.

#### 4.7 Relay Outputs

Refer to the Chillgard Wiring Diagram (Fig. 12) for details.

The Chillgard 5000 has the following five single-pole, double-throw (SPDT) relays. The relay contacts are rated 8 A at 240 Vac/24 Vdc. Each relay can be connected as normally open (NO) or normally closed (NC).

- Fault
- Alarm
- Warning
- Caution
- Horn

#### 4.8 Remote Display



Fig. 13 Chillgard 5000 Remote Display

For installation instructions see the Chillgard 5000 Remote Display Operating Manual 10214065.

## 5 Initial Setup

### WARNING!

Make sure to remove the cap from the exhaust port before operating the device. Failure to do so will create back pressure that can result in inaccurate readings and damage to internal components. Failure to follow these warnings can result in serious bodily injury or death.

Remove the protective film from the touchscreen.



When power is supplied to the device, the green power indicator LED (Fig. 1) illuminates and the touchscreen shows a logo and a loading bar. The loading bar indicates the status of the initializing process.

If an error occurs during start-up, a pop-up identifies the specific problem.

### 5.1 Language/Date & Time/Password



- (1) On the "Initial Setup" screen, select "Language/Date & Time/Password".



- (2) On the "Language Setup" screen, select the appropriate language, then select "Next".

When a language is selected, the change is instantaneous.

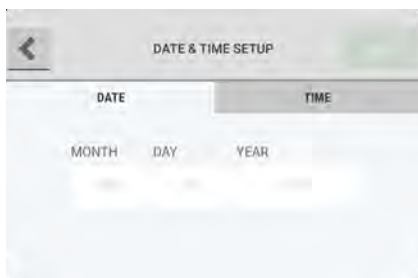

- (3) On the "Date & Time Setup" screen, select the "Date" tab.

The date format can be MM/DD/YYYY or DD/MM/YYYY depending on the language setting.



- (4) Select the "Month/Day/Year" fields, and use the alphanumeric keypad pop-up to enter values. Select  to accept the values.

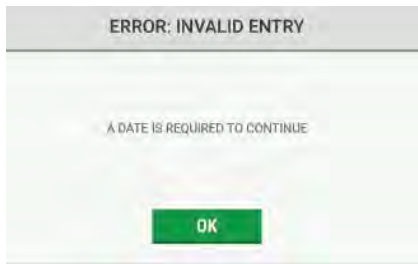

**NOTE:** An entry for the date is necessary to continue. If this error pop-up shows, select "OK" to return to the previous screen and supply a value.

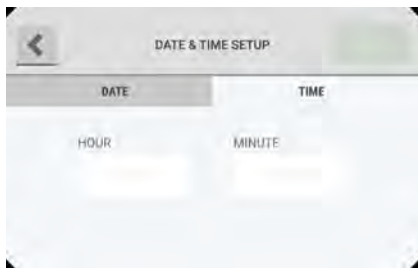

- (5) Select the "Time" tab.  
 (6) Select the "Hour/Minute" fields, and use the alphanumeric keypad pop-up to enter values. Select  to accept the values.

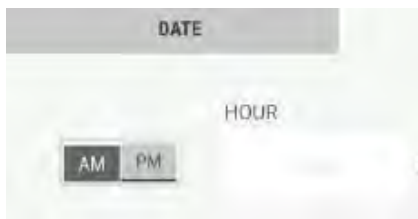

The time format can be 12 hours (AM/PM) or 24 hours depending on the language setting.

- (7) If applicable, select "AM" or "PM".  
 (8) Select "Next".



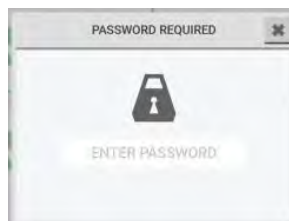
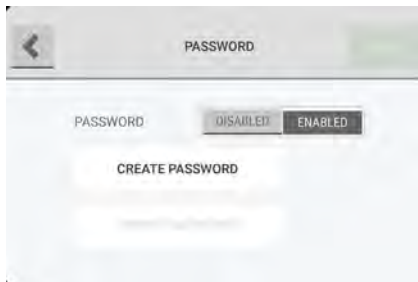

**NOTE:** A valid entry for the time is necessary to continue. If this error pop-up shows, select "OK" to return to the previous screen and supply a value.



- (9) On the "Password" screen, select "Disabled" or "Enabled" to disable or enable password protection for editable screens.

If password protection is disabled, the "Create Password" and "Verify Password" fields are inactive.

**NOTE:** If password protection is enabled, do the following:

- a) Select the "Create Password" field, and use the alphanumeric keypad pop-up to enter a value. Select  to accept the value.
  - b) Select the "Verify Password" field, and use the alphanumeric keypad pop-up to enter a value. Select  to accept the value.
- (10) Select "Next".

If password protection is enabled, the "Password Required" pop-up will show when any user tries to change an editable screen.

- (11) The "Initial Setup" screen shows a check mark beside the "Language/Date & Time/Password" step to indicate that it is complete. Select "Continue" to go to the point configuration setup.

## 5.2 Point Configuration

**NOTE:** At initial setup, all points except Point 1 are disabled by default and are inactive on the "Point Configuration" screen. Configuration of Point 1 is required for device initialization.

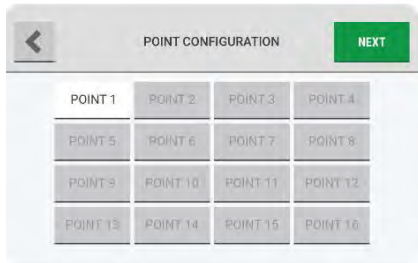

(1) On the "Point Configuration" screen, select "Point 1".

(2) Select "Next".

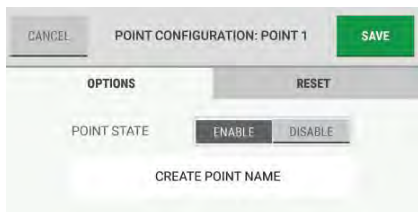

(3) On the "Point Configuration: Point #" screen, select "Enable".

(4) Select the Name field, and use the alphanumeric keypad pop-up to assign a name with up to 18 characters. Select  to accept the value.

The entire 18 characters will only show on the "Point Detail" screen. Only 10 characters will show on the "Point Configuration" screen.

(5) Select "Save".

(6) Repeat Steps (1) through (5) until all of the necessary points have been configured.

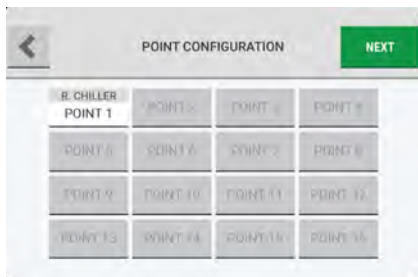

(7) On the "Point Configuration" screen, select "Next".



(8) The "Initial Setup" screen shows a check mark beside the "Point Configuration" step to indicate that it is complete. Select "Continue" to go to the gas configuration setup.

## 5.3 Gas Configuration

### 5.3.1 Configuration for Refrigerant Monitor

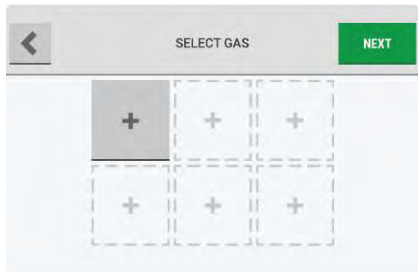

- (1) On the "Select Gas" screen, select an empty gas slot.

**NOTE:** A maximum of six slots or gases can be configured.

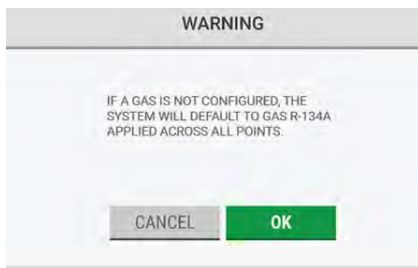

**NOTE:** If "Next" is selected without configuring a gas, a warning pop-up provides an alert that default settings will be applied across all points.

To accept the default settings and bypass the gas configuration step, select "OK". Otherwise, select "Cancel" to return to the "Select Gas" screen and select a gas slot.



- (2) On the "Gases" tab of the "Configure Gas" screen, select from the list of possible configurable gases. The screen header changes to show the selected gas.

**NOTE:** When a gas is selected, the "Save" button becomes active. The interface does not automatically move to the "Setpoints" tab.

If "Save" is selected without adjusting the setpoints for cautions, warnings, and alarms, the default setpoint settings will be used for the selected gas.

- (3) Select the "Setpoints" tab.
- (4) Select the "Edit" button for Caution, Warning, or Alarm, as applicable.



**NOTE:** If the "Setpoints" tab is selected but a gas has not been selected, the options on the "Configure Gas" screen will be inactive.

The options for the configuration settings for cautions, warnings, and alarms are identical.

- (5) In the configuration pop-up, for "State", select "Enabled" or "Disabled".

If "Disabled" is selected, all other options are inactive. Go to Step (8).

CAUTION (0 - 1000ppm) DONE

STATE: ENABLED DISABLED

SETPOINT: 15

ACTION: LATCHING NON-LATCHING

- (6) For "Setpoint", use the and buttons to adjust the value.
- (7) For "Action", select "Latching" or "Non-Latching".

**NOTE:** For a definition of latching and non-latching events, refer to Section 7.5 "Cautions, Warnings, and Alarms".

For a list of default settings, refer to Section 16 "Appendix C: Default Settings".

Use the scroll bar to see all of the configuration options.

CAUTION (0 - 1000ppm) DONE

SETPOINT: 15

ACTION: LATCHING NON-LATCHING

ALARM INDICATION: HORN

STROBE

- (8) To associate an audible horn or a visual strobe with the event, for "Alarm Indication", select the "Horn" and/or "Strobe" check boxes.
- (9) Select "Done" to accept the settings and return to the gas-specific configuration screen, which shows the updated settings.

CANCEL CONFIGURE GAS: R-125A SAVE

GASES	SETPOINTS	POINTS	RESET
CAUTION	-	(DISABLED)	EDIT
WARNING	20 ppm	(ENABLED) HORN, NON-LATCHING	EDIT
ALARM	25 ppm	(ENABLED) HORN, NON-LATCHING	EDIT

- (10) Repeat Steps (2) through (9) until all event setpoints have been configured.

- (11) Select the "Points" tab.
- (12) Select the applicable checkbox to assign a point to the gas.

**NOTE:** If the "Points" tab is selected but a gas has not been selected, the options on the "Configure Gas" screen will be inactive.

Only one gas can be assigned to a single point. Points that have already been assigned a gas are not available for selection.

- (13) Select "Save".
- (14) Repeat Steps (1) through (13) for each gas to be configured.

**NOTE:** The "Reset" tab is not used during the initial setup. For information about the "Reset" tab, refer to Section 7.8.2 "Gas Configuration".

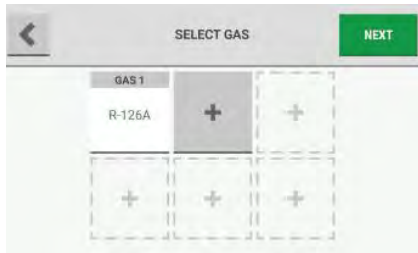

- (15) When all applicable gases have been configured, select "Next".

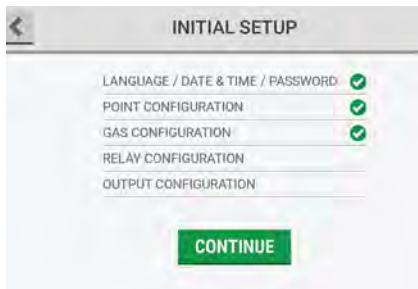

- (16) The "Initial Setup" screen shows a check mark beside the "Gas Configuration" step to indicate that it is complete. Select "Continue" to go to the relay configuration setup.



### 5.3.2 Configuration for Ammonia Monitor

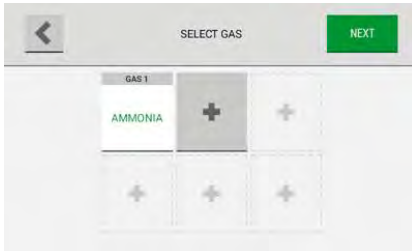

(1) On the "Select Gas" screen, select "AMMONIA". The Chillgard Ammonia monitor can only detect ammonia gas. There can be no other gas added. The 5 other slots are for different alarm settings.

The factory default alarm settings are:

Caution 50 ppm

Warning 200 ppm

Alarm 500 ppm

(2) If all enabled points are to be defined with these settings, click "Next".



Done (The "Initial Setup" screen shows a check mark beside the "Gas Configuration" step to indicate that it is complete. Select "Continue" to go to the relay configuration setup.)

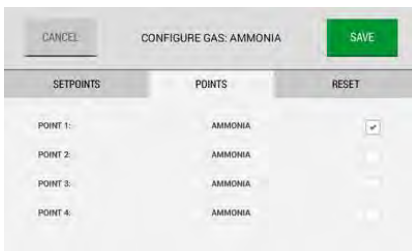

If alarm settings should be different than factory default, select point which should have different settings, delete the check, click "Save".

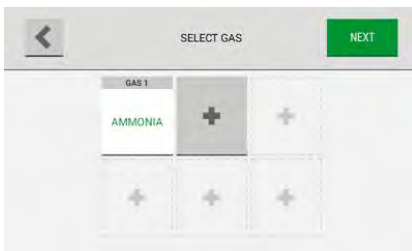

(3) Click on "+" to start setting up a second ammonia alarm setting

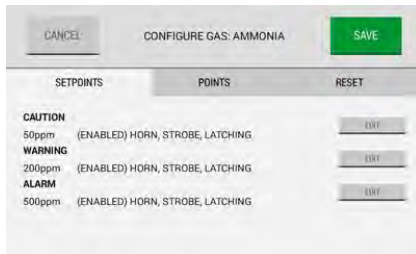

(4) Select "Edit" on set points you want to change



(5) Write requested set point.

Here write the new ppm value.

Make the same changes if needed on Warning and Alarm.

Then click "Done".

Click on Points, make a check on the point you've selected new alarm settings.

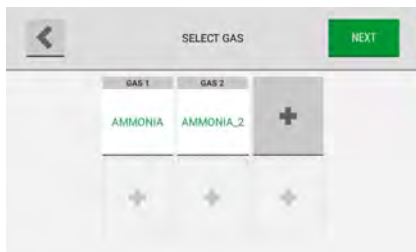

Now next to AMMONIA, AMMONIA\_2, shows up on the select gas screen.

NOTE: The order of AMMONIA, AMMONIA\_2, AMMONIA\_3 etc can change in case of restarting the Chillgard 5000.

## 5.4 Relay Configuration

Each relay is mapped to a specific predetermined function; that is, fault, alarm, warning, caution, or horn.



- (1) On the "Configure Relays" screen, select "Edit" for the function to configure.

**NOTE:** The options for the configuration settings for alarms, warnings, cautions, and the horn are identical.

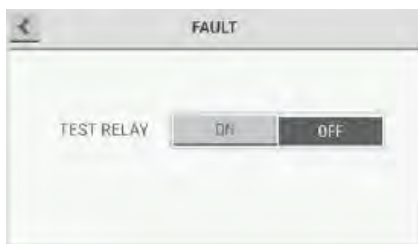

The default setting for the internal fault relay is the energized state. To test the relay, do the following:

- Select "ON".
- Select "OFF".

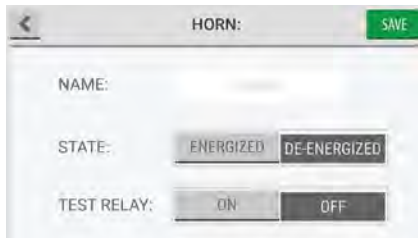

- (2) In the relay configuration pop-up, select the "Name" field, and use the alphanumeric keyboard pop-up to enter a value.

Relay names can have eight characters.

The title in the pop-up header changes to show the assigned name.

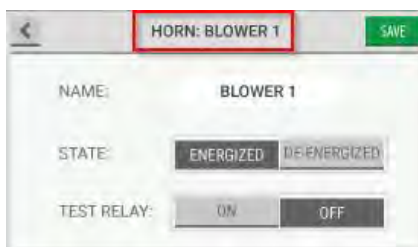

- (3) Select "Energized" or "De-energized" for the relay state.
- (4) Do the following to test the relay:
  - a) Select "ON".
  - b) Make sure the equipment connected to the relay operates as expected.
  - c) Select "OFF".
- (5) Select "Save". The updated settings for the relays show on the "Configure Relays" screen.



(6) Repeat Steps (1) through (5) for each relay to be configured.

(7) When all relays have been configured, select "Next".

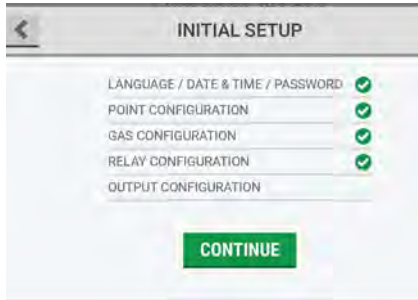

(8) The "Initial Setup" screen shows a check mark beside the "Relay Configuration" step to indicate that it is complete. Select "Continue" to go to the output configuration setup.

## 5.5 Communications Output

There are three options available to support digital outputs.

For a list of the registers that are available for exchange with the Modbus controller, refer to Section 17 "Appendix D: Modbus Holding Registers".

For a list of the BACnet Objects that are available for exchange with the BACnet controller, refer to Section 18 "Appendix E: BACnet Objects".



(1) On the "Digital" tab of the "Outputs" screen, select one of the following:

(2) If "None" is selected, no digital communication is configured.

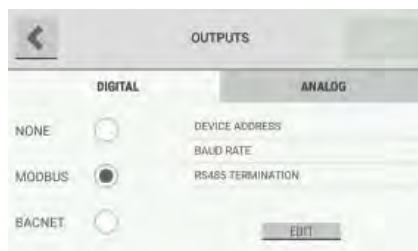

(3) If "Modbus" is selected, do the following:

a) Select "Edit".

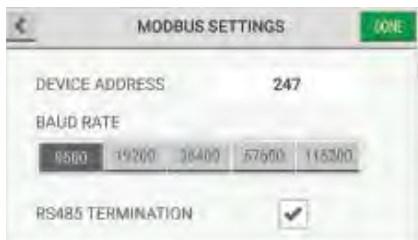

b) Select the "Device Address" field, and use the alphanumeric keypad pop-up to enter a value. Select  to accept the value.



c) Select a baud rate for the connection.

d) Select the RS485 Termination check box.

e) Select "Done".

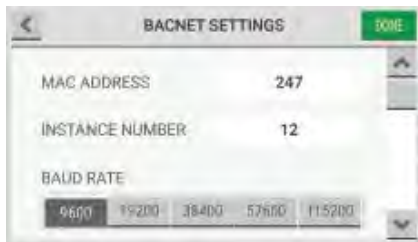
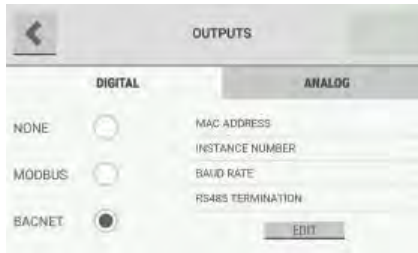
- (4) "If "BACnet" is selected, do the following:  
a) Select "Edit".



- b) Select the "MAC Address" field, and use the alphanumeric keypad pop-up to enter a value. Select  to accept the value.  
c) Select the "Instance Number" field, and use the alphanumeric keypad pop-up to enter a value. Select  to accept the value.  
d) Select a baud rate for the connection.

Use the scroll bar to move through the list of available options.

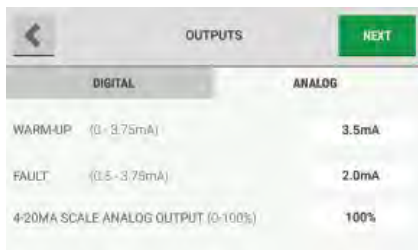

- (5) Select the "Analog" tab.  
(6) To adjust the default values, select the applicable field, and use the alphanumeric keypad pop-up to enter a value. Select  to accept the value.  
(7) Select "Next".

For a list of default settings, refer to Section 16 "Appendix C: Default Settings".

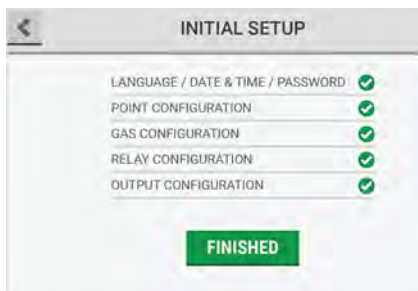

- (8) The "Initial Setup" screen shows that all initial setup steps are complete. Select "Finished" to confirm the configuration settings and move to the "Initial Calibration" screen.

## 6 Calibration

### WARNING!

Make sure the device has been receiving power for at least 2 hours before performing a calibration. Make sure to remove the cap from the exhaust port before operating the device. Failure to do so will create back pressure that can result in inaccurate readings and damage to internal components.

Do NOT do calibration with a constant-flow calibration gas regulator. Use only a demand-flow type regulator (MSA P/N 710269).

Failure to follow this warning can result in incorrect calibration, damage to internal components, and inaccurate gas readings.

If the device does not pass calibration, remove it from service until the issue resulting in failed calibration is corrected and a successful calibration is achieved.

Failure to follow these warnings can result in serious bodily injury or death.

**NOTE:** During the calibration process, the device is not monitoring for gas.

Calibration is the process of applying a known quantity of gas to the device so it can adjust the precision and accuracy of the measurements made during routine operating modes. This process ensures that gas measurements are as accurate as possible.

Although the Chillgard 5000 sensor is factory calibrated, it is recommended that calibration be performed at initial startup and at regular intervals to ensure that the sensor is fully functional and improve the accuracy of the device. Calibration accuracy is dependent on the type of cylinder used. For optimal performance, calibrate with atmospheric background for given application.

There are two types of calibration: zero gas calibration and span gas calibration.

Zero gas calibration resets the baseline level reading to zero. Use the zero-gas scrubber with ambient air for zero calibration.

Span gas calibration applies a known concentration of target gas so the accuracy and precision of the detector can be adjusted to the known value. The known concentration of gas is called a "span value" because it represents the span, or reach, of the calibration curve from zero to that value (Fig. 14).

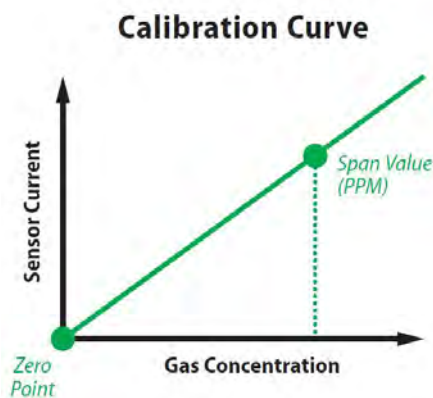

Fig. 14 Calibration curve

The device sensor of the Chillgard 5000 is factory calibrated with R134A, R404A, R410A, R123, R514A, R1233zd(E). The sensor also has an extended pre-programmed library of additional refrigerant gases that can be used to set up the device to detect other targeted refrigerant gases which are listed in section 11.2.

The Chillgard Ammonia monitor is factory calibrated with Ammonia ONLY. No R-gas library is available for the Chillgard Ammonia unit.

### 6.1 Initial Setup

Following the initial setup, an initial calibration must be completed to ensure sensor accuracy.

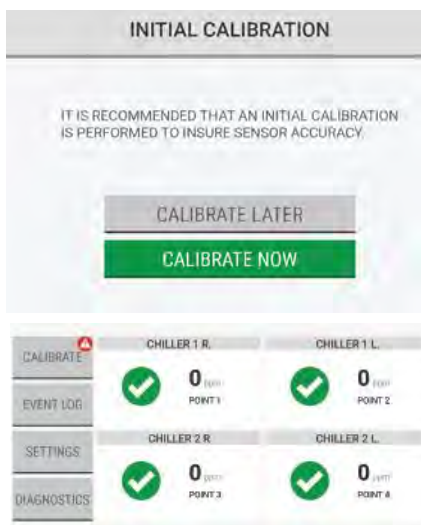

For a description of the dashboard, refer to Section 7.1 "Dashboard Overview".

- (1) On the "Initial Calibration" screen, select "Calibrate Now".
- (2) Go to Step (2) in Section 6.2 "Routine Operation".

**NOTE:** If "Calibrate Later" is selected, the dashboard shows a notification on the "Calibration" button until the initial calibration is completed.

Select "Calibrate" to re-open the "Initial Calibration" screen and select "Calibrate Now".



## 6.2 Routine Operation

### **WARNING!**

Make sure to remove the cap from the exhaust port before operating the device. Failure to do so will create back pressure that can result in inaccurate readings and damage to internal components. Failure to follow these warnings can result in serious bodily injury or death.

### 6.2.1 Starting Calibration



- (1) To start the calibration process, on the dashboard, select "Calibrate".



- (2) On the bottom of the device, remove the cap from the calibration port.



- (3) On the device touchscreen, select "Start".

### 6.2.2 Stopping Calibration

During some phases, when "Cancel" is available in the top left corner, the calibration process can be stopped.

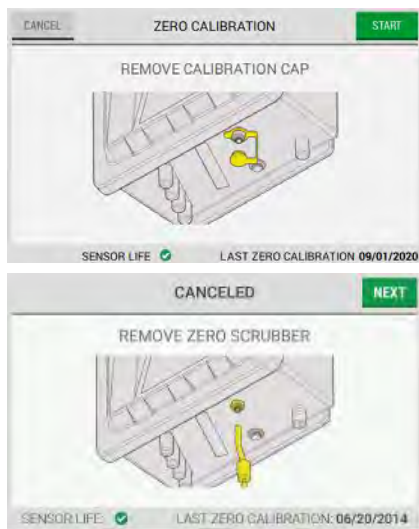

(1) To stop the calibration process, select "Cancel".

(2) For zero-gas calibrations, disconnect the zero-gas scrubber tubing from the calibration port, then select "Next" on the device touchscreen.

(3) On the "Canceled" screen, select "Done".

(4) On the bottom of the device, install the cap on the calibration port.

### 6.3 Zero Gas Calibration

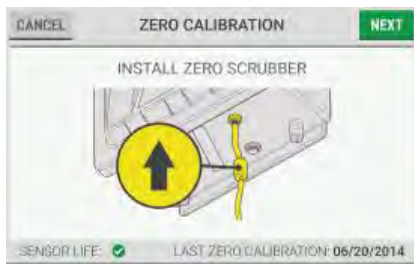

- (1) Connect the zero-gas scrubber tubing to the calibration port.
- (2) On the device touchscreen, select "Next".

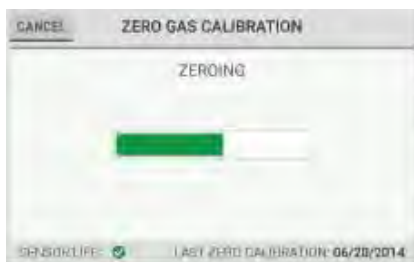

A progress bar shows during the zero gas calibration.

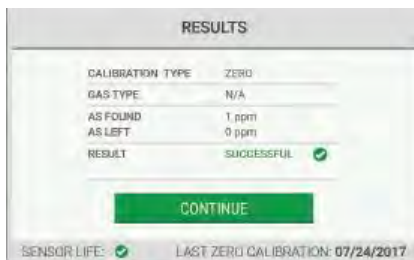

- (3) When zero gas calibration is complete, the "Results" screen shows. Select "Continue" to go to the next step.



- (4) On the "Calibration Complete" screen, do one of the following:
  - a) To continue with span gas calibration, select "Span Gas Calibration". Go to Step (1) in the Span Gas Calibration section below.
  - b) To complete zero gas calibration without continuing to the span gas calibration, select "Done", and go to the next step.
  - c) To return to the "Results" screen, select "Back".



- (5) On the bottom of the device, install the cap on the calibration port.
- (6) Remove the tubing from the calibration port.

US



- (7) Disconnect the zero-gas scrubber tubing from the calibration port.
- (8) On the device touchscreen, select "Next".

## 6.4 Span Gas Calibration

### 6.4.1 Span Gas Calibration Refrigerant Monitor





**NOTE:** To prevent zero-gas contamination, MSA recommends using different regulators to do zero gas calibration and span gas calibration.

- (1) Close the cylinder valve.
- (2) If applicable, remove the zero-gas cylinder or zero-gas scrubber tubing from the calibration port. *On the "Span Gas Calibration" screen, the gases are displayed that have been selected in the Gas Configuration.*

- (3) Select the applicable span gas.

**NOTE:** A maximum of seven gases show on the "Select Gas" screen: six user-selected gases and one universal gas (Synthetic R-134A).

- (4) On the gas cylinder label, find the concentration for the gas.
- (5) On the "Set Span Gas Value" screen, to adjust the concentration value to the value on the gas cylinder label, either use the  and  buttons to increase or decrease the value in 1 ppm increments, or select the value field and use the alpha-numeric keypad pop-up to enter the value. Select  to accept the value.
- (6) To do the calibration with synthetic R-134A, select the check box.
- (7) Select "Next".

**NOTE:** The concentration value can be set between 10 and 500 ppm. MSA recommends a concentration value of 100 ppm.

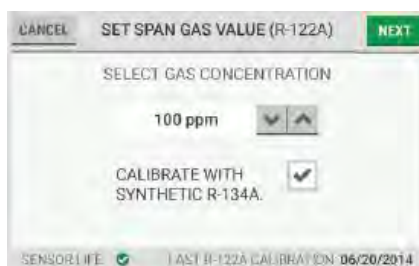

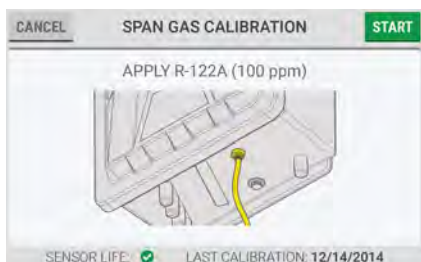

- (8) Attach the span-gas cylinder tubing to the calibration port.
- (9) Open the span-gas cylinder valve.
- (10) On the "Span Gas Calibration" screen, select "Start".

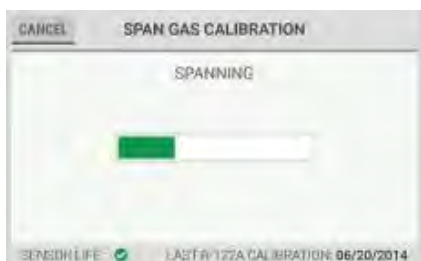

A progress bar shows during the span gas calibration.



- (11) When span gas calibration is complete, the "Results" screen shows. Select "Continue".



- (12) On the "Calibration Complete" screen, do one of the following:
  - a) To do a span gas calibration for another gas, select "Select Another Gas". Repeat Steps (3) through (11).
  - b) To return to the "Results" screen, select "Back".
  - c) To go to the next step, select "Continue".

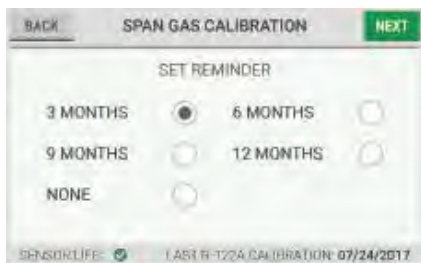

- (13) Close the span gas cylinder valve.
- (14) On the "Set Reminder" screen, select the applicable button for the calibration interval. At the selected interval, a pop-up will signal the need for calibration.

**NOTE:** Calibration should be performed regularly. MSA recommends a frequency of 6 months between calibration, with a log of calibration adjustments maintained. Calibration frequency depends on the operating time and chemical exposures of the instrument.

Calibration should be performed when installing or changing the power source of the instrumentation.

- (15) Select "Next".





- (16) On the bottom of the device, install the cap on the calibration port.
- (17) Remove the tubing from the calibration port.
- (18) On the device touchscreen, select "Done".

### 6.4.2 Span Gas Calibration Ammonia Monitor

**NOTE:** To prevent zero-gas contamination, MSA recommends using different regulators to do zero gas calibration and span gas calibration.

- (1) Close the cylinder valve.
- (2) If applicable, remove the zero-gas cylinder or zero-gas scrubber tubing from the calibration port.
- (3) On the "Span Gas Calibration" screen, select the ammonia with your preferred alarm setting.  
100 ppm = gas cylinder 100 ppm
- (4) Click "Next".

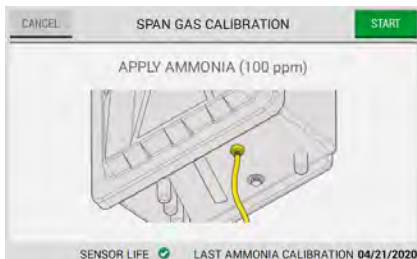

- (5) Click "Start".

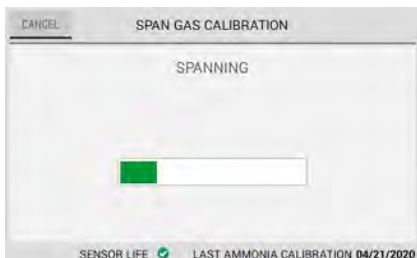

A progress bar shows during the span gas calibration.



- (6) When span gas calibration is complete, the "Results" screen shows. Select "Done".

US

### 6.5 Unsuccessful Calibrations

In the unlikely event that a problem occurs during a calibration process, the "Results" screen will show the calibration status as "Unsuccessful".

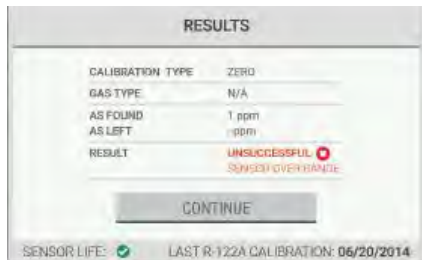

(1) On the "Results" screen, select "Continue".

(2) On the "Calibration Unsuccessful" screen, do one of the following:

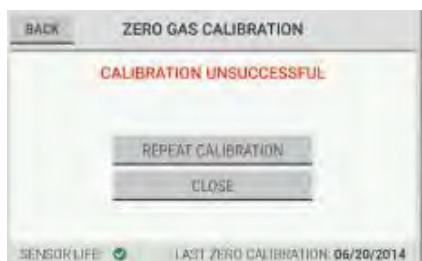

a) For zero gas calibrations:

To retry the zero gas calibration, select "Repeat Calibration".

To return to the previous calibration values, select "Close".

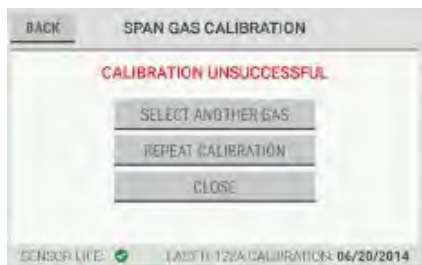

b) For span gas calibrations:

To do a span gas calibration for another gas, select "Select Another Gas".

**NOTE:** This option does not show up for ammonia.

To retry the span gas calibration, select "Repeat Calibration".

To return to the previous calibration values, select "Close".



If "Close" is selected, on the dashboard, a gray check mark identifies the points that are affected by the unsuccessful calibration. The gas readings for these sample points are below the alarm threshold but may not be completely accurate.

US

## 7 Routine Operation

### **WARNING!**

Make sure to remove the cap from the exhaust port before operating the device. Failure to do so will create back pressure that can result in inaccurate readings and damage to internal components. Failure to follow these warnings can result in serious bodily injury or death.

### 7.1 Dashboard Overview

After the initial setup, the dashboard shows the main function buttons and tiles for the points that are enabled.

A green box around the tile identifies the point currently being sampled.

Point tiles are titled by name, not number.



When 2–4 points are enabled, large tiles show the point name, number, current gas reading, and status.



When 5–8 points are enabled, medium tiles show the point name, number, current gas reading, and status.



When 9–16 points are enabled, small tiles show the point name, number, current gas reading, and status.





## 7.2 Point Details



To see details about a specific point, on the dashboard, select the point tile. A detail pop-up opens.

To close the detail pop-up and return to the dashboard, select the X at the top right corner.

To hold and lock onto a point for an extended period manually, in the point detail pop-up, select "Hold".

## 7.3 Point Hold

### 7.3.1 Automatic Point Hold

During routine operation, when any sample point detects gas that results in a caution/warning/alarm (C/W/A), the device automatically holds that sample point for an additional four gas measurement cycles to analyze the point further and provide more data. When the additional four measurement cycles are complete, the device goes to the next point and resumes routine sample times.

When the sampling cycle returns to the point that triggered the automatic hold, the automatic hold state continues unless the non-latching event no longer exists (that is, the gas concentration decreases below the C/W/A threshold) or the latching alarm event has been reset.

### 7.3.2 Manual Point Hold

To set the duration of the Hold feature, use the  and  buttons.

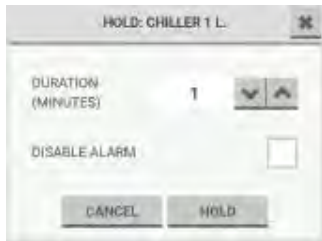

To disable the point alarm for the duration of the hold, select the "Disable Alarm" checkbox.

To activate the Hold feature, select "Hold".

To cancel the Hold feature, select "Cancel" or the X at the top right corner.



**NOTE:** The Hold feature can only be applied to one point at a time. During the hold duration for the selected point, the "Hold" button is inactive for all other points until the hold duration for the selected point has completed.

US

### 7.4 Predictive Warnings

When a point goes above the acceptable threshold for flow rate, sensor performance, or pump performance, a predictive warning pop-up shows on the dashboard.

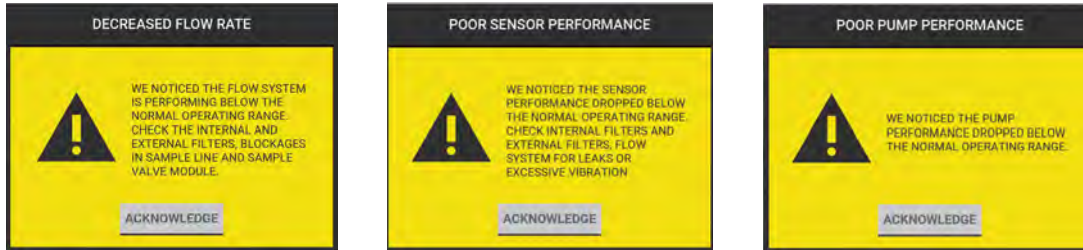

Predictive warnings indicate that it may be necessary to do troubleshooting or replace a part, not that there is a critical issue with the flow rate, sensor, or pump.

To acknowledge the predictive warning and return to the dashboard, select "Acknowledge".

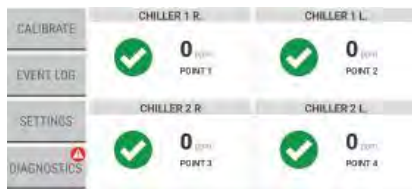

Acknowledging the predictive warning triggers a notification that shows on the "Diagnostics" button on the dashboard.

A corresponding notification also shows on the "Diagnostics" screen. For information about diagnostics, refer to Section 8 "Diagnostics".

## 7.5 Cautions, Warnings, and Alarms

Cautions, warnings, and alarms can be triggered by non-latching or latching events. Non-latching events do not require user interaction for resolution. Latching events require user interaction for resolution.

When an event occurs, a pop-up shows on the dashboard.



### 7.5.1 Non-Latching Events

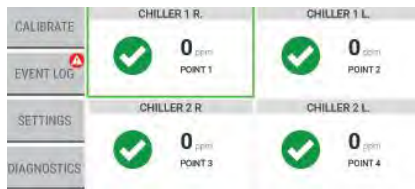

Non-latching events do not require user interaction for resolution. For a non-latching event, if the gas reading goes below the caution, warning, or alarm threshold before "Acknowledge" is selected, the pop-up disappears from the dashboard, the background of the point tile on the dashboard changes from red to white, the event is catalogued in the Event Log, and a notification shows on the "Event Log" button on the dashboard.

For information about the Event Log, refer to Section 7.7 "Event Log".

A corresponding notification of the event shows on the "Diagnostics" screen. For information about diagnostics, refer to Section 8 "Diagnostics".

### 7.5.2 Latching Events



Latching events require user interaction for resolution. For a latching event, "Acknowledge" must be selected on the pop-up to return to the dashboard. If a horn is enabled for the point, selecting "Acknowledge" silences the horn, but the event is not yet resolved. The point tile shows in red on the dashboard to indicate the unresolved event.

Select the point tile with the event to see a detail pop-up.





While the gas reading is above the event threshold, the "Reset" button on the detail pop-up is hidden, and the event cannot be resolved.



When the gas reading goes below the event threshold, the "Reset" button is active.

Select "Reset" to resolve the event and return to the dashboard. The point tile on the dashboard shows in its normal state, and the event is considered resolved.

A corresponding notification of the event shows on the "Diagnostics" screen. For information about diagnostics, refer to Section 8 "Diagnostics".

## 7.6 Faults

### WARNING!

If the device is in critical fault mode, the device will not be monitoring for gas. Failure to follow these warnings can result in serious bodily injury or death.

There are two types of faults: noncritical and critical.

Alarm events have priority over fault events. If a point has an alarm during a fault event, the point tile on the dashboard shows in red to indicate the alarm, not in yellow to indicate the fault.

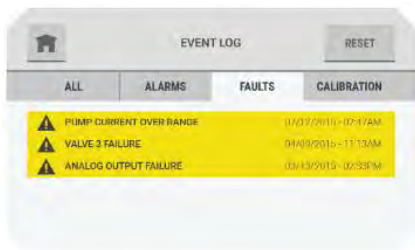

Faults can be acknowledged and reset through the pop-up if it is a channel related fault.

If the fault is system related, it is acknowledged and reset through the fault tab in the event log. Once the reset is initiated on the system related faults, it will reset all of the faults concurrently.

For faults related to the display, the system will notify the user upon reset.

7.6.1 Noncritical Faults

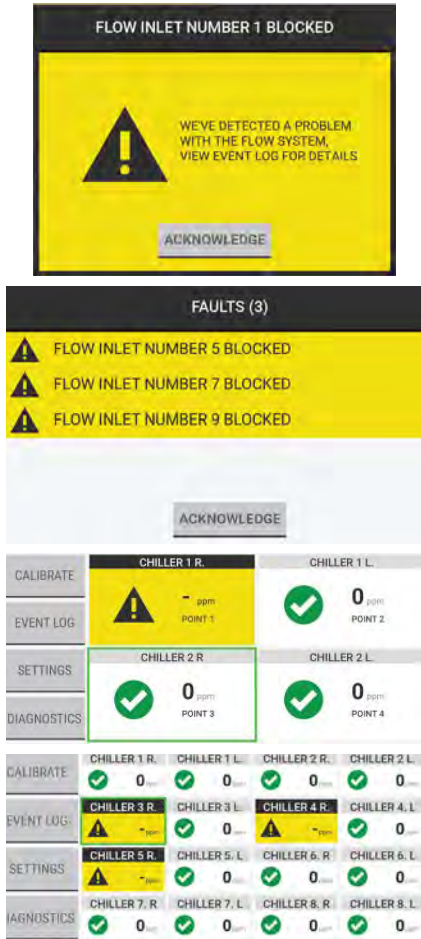

When a noncritical fault occurs, a pop-up with a yellow background signals the event on the dashboard.

If multiple faults occur simultaneously, the pop-up shows the faults as line items.

To acknowledge the event and return to the dashboard, select "Acknowledge".

If the fault can be related to a single or multiple points, the associated point tiles show on the dashboard with a yellow background.

If the fault cannot be related to a single point or multiple points, the dashboard shows in a normal state.

To see the details about a specific point, on the dashboard, select the point tile.

To see the details about the fault itself, go to the Event Log, "Faults" tab. Refer to Section 7.7 "Event Log".



### 7.6.2 Critical Faults

**⚠ WARNING!**

If the device is in critical fault mode, the device will not be monitoring for gas. Failure to follow these warnings can result in serious bodily injury or death.

A critical fault causes the following to occur:



- The fault relay trips.
- The device cannot monitor for gas.
- The 4–20 mA output decreases to the user-specified fault level.
- All modules except the main board and display shut down.
- All point tiles show on the dashboard with a yellow background and a black X icon.



**NOTE:** If more than four events occur, use the scroll bar to see the entire list of faults.

To acknowledge the events collectively and return to the dashboard, select "Acknowledge".

### 7.7 Event Log



On the dashboard, select the "Event Log" button.

US

### 7.7.1 All

The "All" tab shows a list of all types of events for the device.

The last 25 events show in chronological order. When there are 25 events in the list and a new event occurs, the oldest event is deleted to make space for the new event to show.

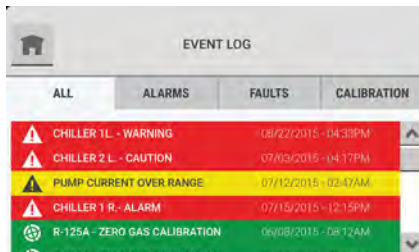

Use the scroll bar to move through the list of events.

In the Event Log, events are color coded by type:

- Red = Caution, Warning, Alarm
- Yellow = Fault, Unsuccessful Calibration
- Green = Successful Calibration



Select any event on the "All" tab to see a pop-up with the event details.

### 7.7.2 Alarms

The "Alarms" tab shows a list of alarm events for the device.

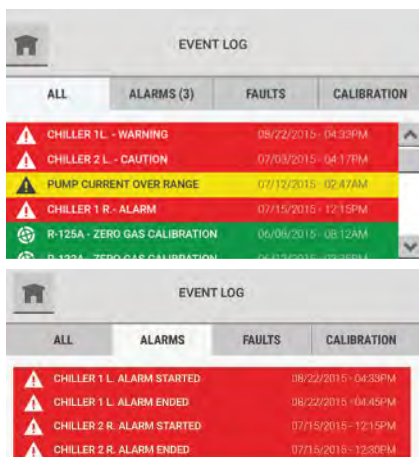

Non-latching alarm events that resolved without being acknowledged are indicated by a number in parentheses after the "Alarms" tab heading.

A single alarm event is divided into two events in the event log: one for the initiation of the alarm and another for the conclusion of the alarm.

The last 100 events show in chronological order. When there are 100 events in the list and a new event occurs, the oldest event is deleted to make space for the new event to show.

Use the scroll bar to move through the list of events.





Select any event on the "Alarms" tab to see a pop-up with event details.

### 7.7.3 Faults

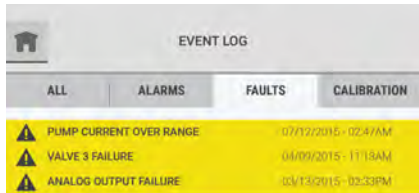

The "Faults" tab shows a list of all fault events for the device.

The last 100 events show in chronological order. When there are 100 events in the list and a new event occurs, the oldest event is deleted to make space for the new event to show.

Use the scroll bar to move through the list of events.

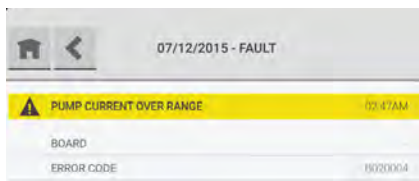

Select any event on the "Faults" tab to see a pop-up with event details. The detailed view shows the board location, if applicable, and the software error code.

### 7.7.4 Calibration

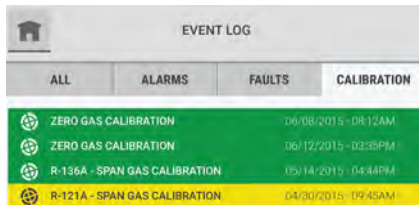

The "Calibration" tab shows a list of calibration attempts for the device.

The last 20 calibrations show in chronological order. When there are 20 calibrations in the list and a new calibration occurs, the oldest calibration is deleted to make space for the new calibration to show.

Use the scroll bar to move through the list of events.

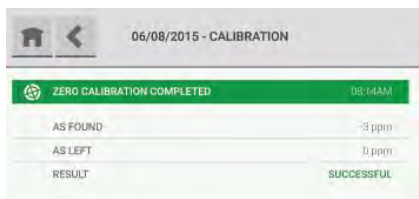

Select any calibration event to see a pop-up with details.

**NOTE:** The "As Found" value represents the performance reading before calibration is performed. The "As Left" value represents the performance reading after calibration is performed.





## 7.8 Edit Settings



To access and edit the device settings that were assigned during the initial setup, on the dashboard, select the "Settings" button.

If password protection was enabled during the initial setup, on the "Password Required" pop-up, enter the correct password.

For help with forgotten passwords or password resets, contact local MSA Customer Service.

### 7.8.1 Preferences

Use the "Preferences" option to change the settings for the language, date and time, password, and brightness of the device display.



On the "Settings" screen, select "Preferences".

The "Preferences" screen shows the current values for the settings. Select the "Edit" button for the setting to change.

#### Language, Date and Time, and Password

**NOTE:** If the date setting is changed after the initial set up configuration, the predictive maintenance logs will need to be reset on each graph to ensure accuracy.

Except for the buttons that show in the screen headers, the screens and steps used to change the settings for the language, date and time, and password are the same as those used during the initial setup.

During the initial setup, the screen headers show the **NEXT** and buttons. During routine operation, the screen headers show the and buttons.

To adjust the settings for the language, date and time, and password, go to Section 5 "Initial Setup", and do Steps (2) through (10).

To return to the "Settings" screen, select .

To return to the previous screen, select .



### Brightness

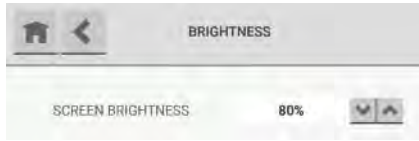

On the "Brightness" screen, use the and buttons to increase and decrease the percentage of screen brightness.

### 7.8.2 Gas Configuration

Use the "Gas" option to change the gas configuration settings.

**NOTE:** Except for the buttons that show in the screen headers, the screens and steps used to change the gas configuration settings are the same as those used during the initial setup.

During the initial setup, the screen headers show the and buttons. During routine operation, the screen headers show the , , and buttons.

When a change is made to the configuration, the "Save" button becomes active.

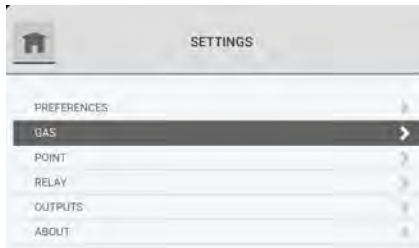

(1) On the "Settings" screen, select "Gas".



(2) On the "Gas" screen, select the applicable gas tile.

(3) Do one of the following:

- a) To change the gas configuration settings, go to Section 5.3 "Gas Configuration", and do Steps (2) through (13).
- b) To clear or delete a configured gas, go to Step (1) in the "Reset" Tab section below.

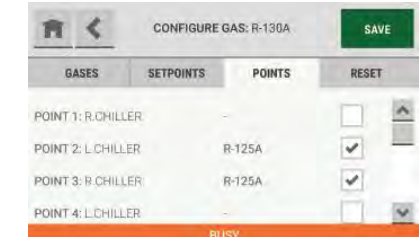

While the configuration is being updated, a "Busy" message shows at the bottom of the "Configure Gas" screen.



If the or button is selected while the "Busy" message shows, a pop-up asks whether to abandon the configuration changes.

- To return to the "Gas" screen without saving the configuration changes, select "Return without Saving".
- To save the configuration changes and return to the "Configure Gas" screen, select "Save and Return".

When the configuration changes have been saved, the "Settings" screen shows.



### "Reset" Tab

Use the "Reset" tab to clear or delete a gas slot.

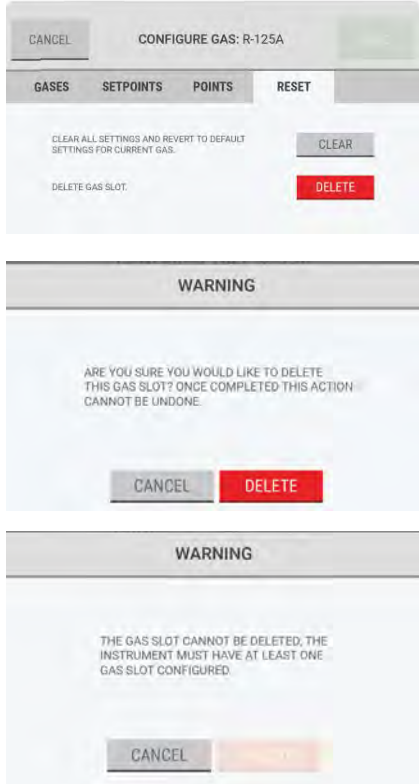

- (1) On the "Configure Gas" screen, select the "Reset" tab.
- (2) Do one of the following:
  - a) To return to the default settings for the currently selected gas, select "Clear".
  - b) To remove the gas slot completely, select "Delete".
- (3) On the warning pop-up, do one of the following:
  - a) To cancel the Delete function, select "Cancel".
  - b) To continue with the Delete function, select "Delete".

**NOTE:** If only one gas slot is configured, it cannot be deleted. At least one gas slot must be configured for the system to function. If an attempt is made to delete the only configured gas slot, a warning pop-up indicates that the action cannot be completed.

Select "Cancel" to return to the "Configure Gas" screen.

When the configuration changes have been saved, the "Settings" screen shows.

### 7.8.3 Point Configuration

Use the "Point" option to change the point configuration settings.



- (1) On the "Settings" screen, select "Point".
- (2) On the "Point" screen, select the applicable point.

US

- (3) On the "Point Configuration: Point #" screen, do one of the following:

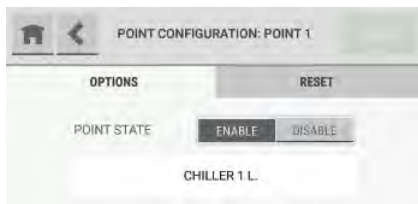

- a) To change the point configuration settings, select the "Options" tab, and go to Step (4).
- b) To reset the point name and disable the point, go to Step (1) in the "Reset" Tab section below.

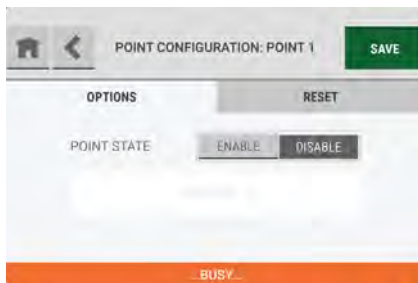

**NOTE:** When a change is made to the configuration, the "Save" button becomes active.

- (4) To change the point state, select "Enable" or "Disable". If "Disable" is selected, the "Create Point Name" field is inactive.
- (5) To change the point name, select the name field, and use the alphanumeric keypad pop-up to assign a name with up to 18 characters. Select  to accept the value. The entire 18 characters will only show on the "Point Detail" screen. Only 10 characters will show on the "Point Configuration" screen.
- (6) Select "Save".



While the configuration is being updated, a "Busy" message shows at the bottom of the "Point Configuration: Point #" screen.



If the  or  button is selected while the "Busy" message shows, a pop-up asks whether to abandon the configuration changes.

- To return to the "Point" screen without saving the configuration changes, select "Return without Saving".
- To save the configuration changes and return to the "Point" screen, select "Save and Return".

When the configuration changes have been saved, the "Settings" screen shows.

## "Reset" Tab

Use the "Reset" tab to reset the point name and disable the point.

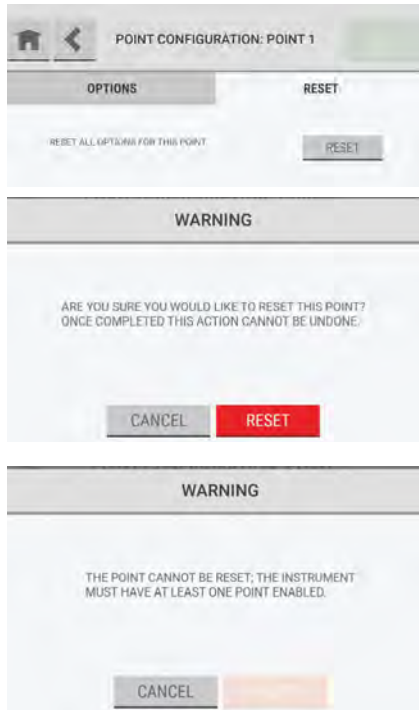

- (1) On the "Point Configuration: Point #" screen, select the "Reset" tab.
- (2) Select "Reset".
- (3) On the warning pop-up, do one of the following:
  - a) To return to the "Point Configuration: Point #" screen without resetting the point, select "Cancel".
  - b) To reset the point name, disable the point, and return to the "Settings" screen, select "Reset".

**NOTE:** If only one point is configured, it cannot be deleted. At least one point must be configured for the system to function. If an attempt is made to delete the only configured point, a warning pop-up indicates that the action cannot be completed.

Select "Cancel" to return to the Point Configuration: Point #" screen.

When the configuration changes have been saved, the "Settings" screen shows.

### 7.8.4 Relay Configuration

Use the "Relay" option to change the relay configuration settings or test a relay.

**NOTE:** Except for the buttons that show in the screen headers, the screens and steps used to change the relay configuration settings are the same as those used during the initial setup.

During the initial setup, the screen headers show the **NEXT** and **<** buttons. During routine operation, the screen headers show the **HOME**, **<**, and **SAVE** buttons.

When a change is made to the configuration, the "Save" button becomes active.

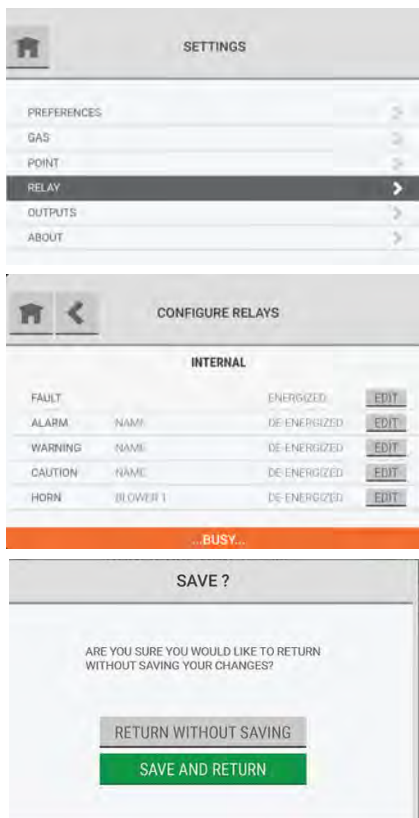

On the "Settings" screen, select "Relay".

To adjust the relay configuration settings, go to Section 5.4 "Relay Configuration", and do Steps (1) through (5).

While the configuration is being updated, a "Busy" message shows at the bottom of the "Configure Relays" screen.

If the **HOME** or **<** button is selected while the "Busy" message shows, a pop-up asks whether to abandon the configuration changes.

- To return to the "Configure Relays" screen without saving the changes, select "Return without Saving".
- To save the changes and return to the "Configure Relay" screen, select "Save and Return".

When the configuration changes have been saved, the "Settings" screen shows.



### 7.8.5 Communications Output

Use the "Outputs" option to change the configuration settings for digital and analog outputs.

**NOTE:** Except for the buttons that show in the screen headers, the screens and steps used to change the output settings are the same as those used during the initial setup.

During the initial setup, the screen headers show the **NEXT** and **←** buttons. During routine operation, the screen headers show the **🏠**, **←**, and **SAVE** buttons.

When a change is made to the configuration, the "Save" button becomes active.

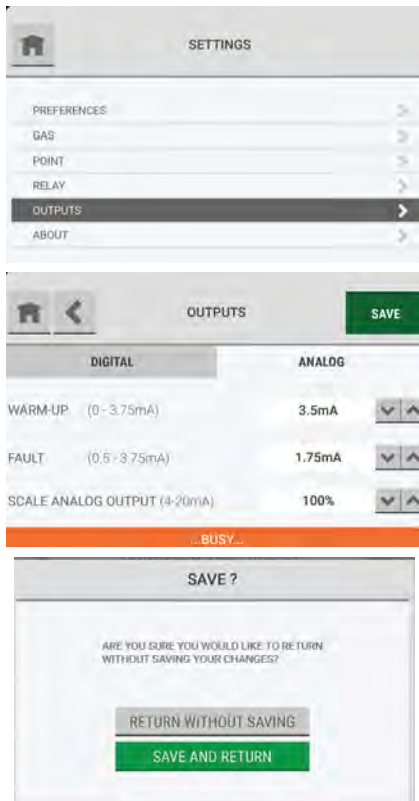

On the "Settings" screen, select "Outputs".

To adjust the output configuration settings, go to Section 5.5 "Communications Output", and do Steps (1) to (3).

While the configuration is being updated, a "Busy" message shows at the bottom of the "Outputs" screen.

If the **🏠** or **←** button is selected while the "Busy" message shows, a pop-up asks whether to abandon the configuration changes.

- To return to the "Outputs" screen without saving the changes, select "Return without Saving".
- To save the changes and return to the "Outputs" screen, select "Save and Return".

When the configuration changes have been saved, the "Settings" screen shows.



### 7.8.6 About

The "About" option shows information about the device and its component parts.

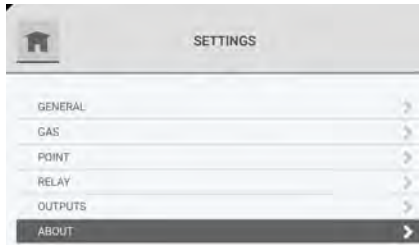

On the "Settings" screen, select "About".



Use the scroll bar to see all of the available information.





## 8 Diagnostics

**NOTE:** If the date setting is changed after the initial set up configuration, the predictive maintenance logs will need to be reset on each graph to ensure accuracy.



When a predictive warning, fault, or alarm is acknowledged, a notification shows on the "Diagnostics" button on the dashboard.

- (1) On the dashboard, select the "Diagnostics" button.

### 8.1 Flow Diagnostics



- (2) On the "Diagnostics" screen, select "Flow Diagnostics".

The "Flow Diagnostics" screen shows data for four points. If more than four points are enabled, additional tabs show the points in groups of four.

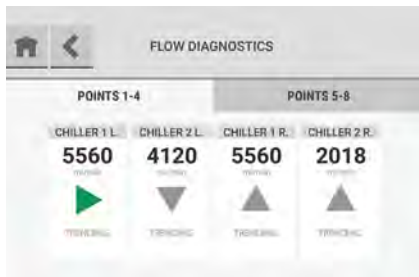

The flow rate for each point shows below the point name.

A directional arrow indicates the trending behavior of the flow rate for a point. The arrow is green only when the trend is static. The arrow is gray in other situations because a positive or negative trend indicates a change in the system.

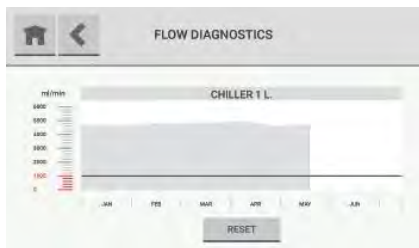

To see a detailed graph of the flow data for a point over time, select the point tile.

US

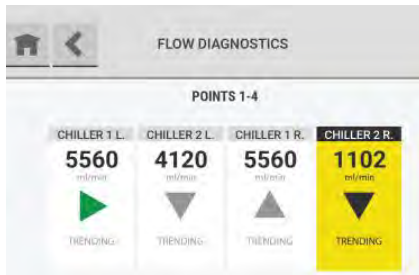

The background of point tiles associated with a predictive warning is yellow.

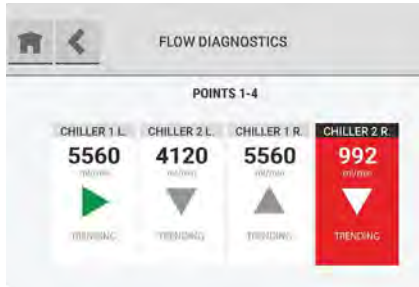

The background of point tiles associated with an alarm is red.

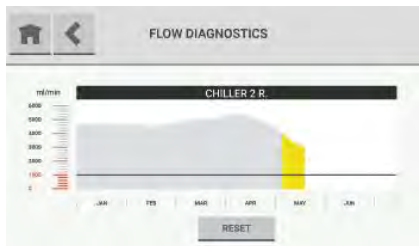

Values below the predictive warning threshold show in yellow.

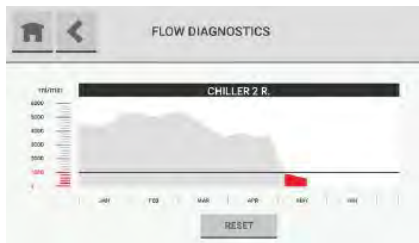

Values below the alarm threshold show in red.

To reset the flow diagnostics baseline, select "Reset".



In the Warning pop-up, select "Reset" to continue the reset function or "Cancel" to cancel it.

US

## 8.2 Sensor Performance



- (1) On the dashboard, select the "Diagnostics" button.
- (2) On the "Diagnostics" screen, select "Sensor Performance".



The "Sensor Performance" screen shows a graph of sensor performance over a 6-month interval. The graph is divided into quadrants. Each quadrant indicates a particular sensor status.

The top left quadrant is associated with normal performance.



To see details about sensor performance, select the text box.



The bottom left and top right quadrants show predictive warnings in yellow. When the highlighted section shows below the trend line, it identifies the Poor threshold.

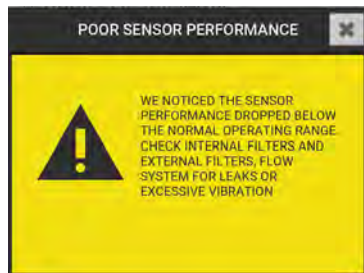

To see details about sensor performance in this quadrant, select the text box.



The bottom right quadrant shows predictive warnings in red. When the highlighted section shows below the trend line, it identifies the Poor threshold.



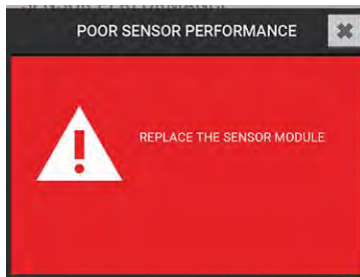

To see details about sensor performance in this quadrant, select the text box.



To reset the sensor performance baseline, select "Reset".

In the Warning pop-up, select "Reset" to continue the reset function or "Cancel" to cancel it.

### 8.3 Pump Performance

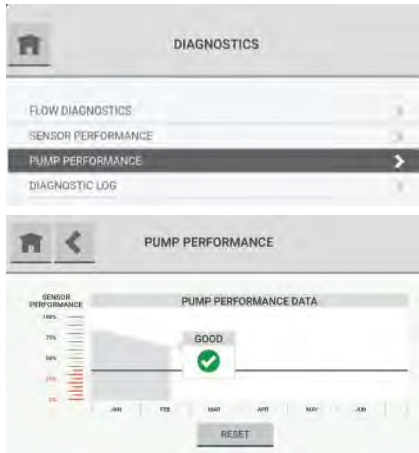

- (1) On the dashboard, select the "Diagnostics" button.
- (2) On the "Diagnostics" screen, select "Pump Performance".

The "Pump Performance" screen shows a graph that plots pump performance over time.



To see details about pump performance, select the text box.

To reset the pump performance baseline, select "Reset".

In the Warning pop-up, select "Reset" to continue the reset function or "Cancel" to cancel it.

The region of the graph that is below the predictive warning threshold shows in yellow or red, depending on the severity of the performance degradation. To see details about pump performance, select the text box.

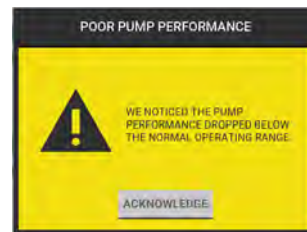
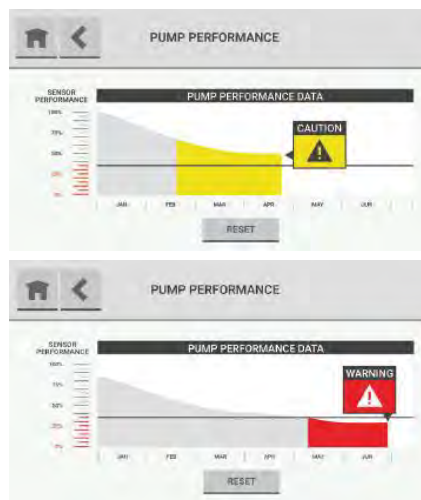

US

### 8.4 Errors

Errors are events that do not result in a fault condition but that may impact the general performance of the device.

A notification of the event shows on the "Diagnostics" screen. For information about diagnostics, refer to Section 8 "Diagnostics".

**NOTE:** A notification shows on the "Diagnostics" button on the dashboard until the error is resolved.

- (1) On the dashboard, select the "Diagnostics" button.
- (2) On the "Diagnostics" screen, select "Diagnostic Log".

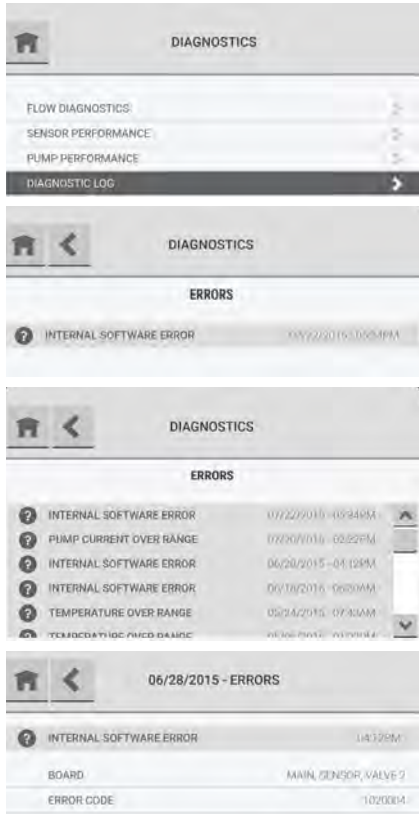

A list shows the device errors.

If there are multiple errors, use the scroll bar to move through the list of events.

To see details about an error, select it.



## 9 Maintenance

Obey the following Cautions and Warnings for all maintenance procedures.

### **⚠ WARNING!**

To prevent electrostatic discharge (ESD), connect an ESD wrist strap to the ESD connection point inside the device enclosure before doing work inside the enclosure. ESD can cause damage to the device.

Do not touch the electronic circuit boards.

Disconnect ac power before opening the device enclosure. Failure to do so can result in electrical shock. Electrical shock can cause damage to the device and injury to personnel.

Failure to follow these warnings can result in serious bodily injury or death.

Under routine operating conditions, the device requires the following scheduled maintenance procedures:

- Examine and replace end-of-line filters
- Examine and replace internal inline filters

### 9.1 Scheduled Maintenance

#### 9.1.1 Examine and Replace End-of-Line Filters

### **⚠ WARNING!**

Failure to use and maintain end-of-line filters can cause inaccurate readings and damage to internal components, and make additional servicing necessary.

Failure to follow these warnings can result in serious bodily injury or death.

Examine the end-of-line filters periodically for dirt and particulate buildup.

Replace dirty filters when necessary. For a list of approved parts and how to order them, refer to Section 13 "Ordering Information".

If an end-of-line filter becomes severely clogged with particulates, the flow rate for that sample line will decrease and eventually cause a flow rate fault.

Do the following procedure to replace an end-of-line filter:



- (1) Disconnect the dirty filter from the sample line tubing.
- (2) Discard the dirty filter.
- (3) Remove the new end-of-line filter from the bag.
- (4) Slide the end of the end-of-line filter with flexible tubing onto the sample line tubing. Make sure the arrow on the body of the filter points in the direction of air flow into the sample line.

### 9.1.2 Examine and Replace Internal Inline Filters

Inline filters are installed inside the device enclosure (Fig. 15).

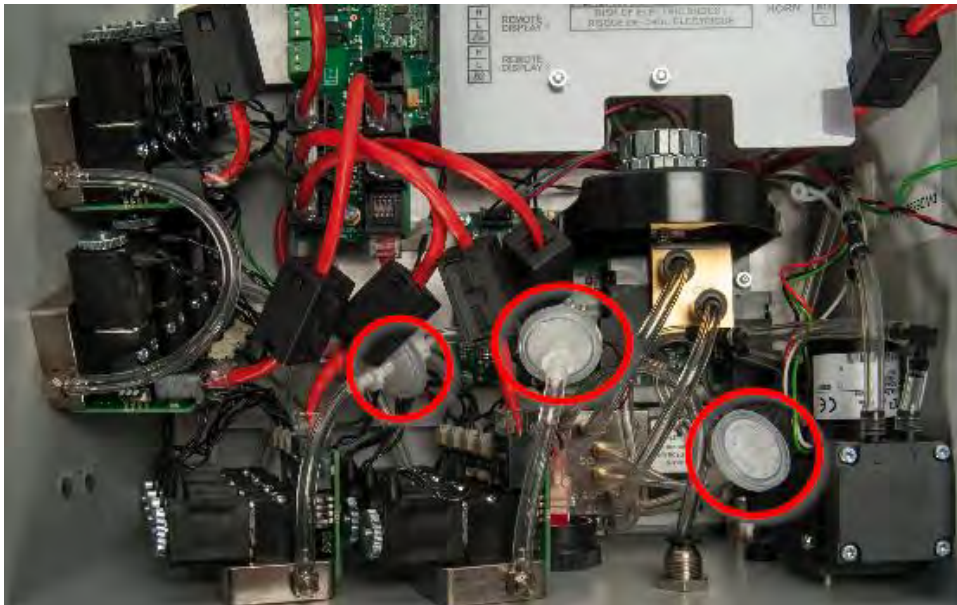

Fig. 15 Location of inline filters

Periodically examine the inline filters inside the device enclosure for dirt and particulate buildup.

If the inline filters become severely clogged with particles or moisture, the flow rate for the device will decrease and eventually cause a flow fault.

Replace dirty filters when necessary to prevent damage to internal components. For a list of approved parts and how to order them, refer to Section 13 "Ordering Information".

Do the following procedure to replace the inline filters:

- (1) Disconnect electrical power to the device.
- (2) If applicable, remove the locking mechanism.
- (3) Release the two latches on the left side of the device.
- (4) Open the enclosure.
- (5) Attach the ESD wrist strap to the ESD connection point inside the enclosure.
- (6) Twist the Luer locks on both ends of the inline filter to release the filter from the tubing.
- (7) Discard the dirty filter.
- (8) Remove the new inline filter from the bag.
- (9) Install one end of the new filter into the Luer lock and twist to lock the filter in position.
- (10) Twist the free end of tubing slightly so that it will be straight when it's connected to the filter.
- (11) Install the free end of the new filter into the Luer lock on the free end of tubing and twist to lock the filter in position.
- (12) Make sure the new filter fits snugly into both ends of the tubing.



- (13) Disconnect the ESD wrist strap from the ESD connection point inside the enclosure.
- (14) Close the enclosure.
- (15) Latch the two latches.
- (16) If applicable, attach the locking mechanism.
- (17) Supply electrical power to the device.

### 9.1.3 Replace Fuses

The device uses 2 amp, 240 V fuses (MSA P/N 10185821 or an equivalent certified fuse).

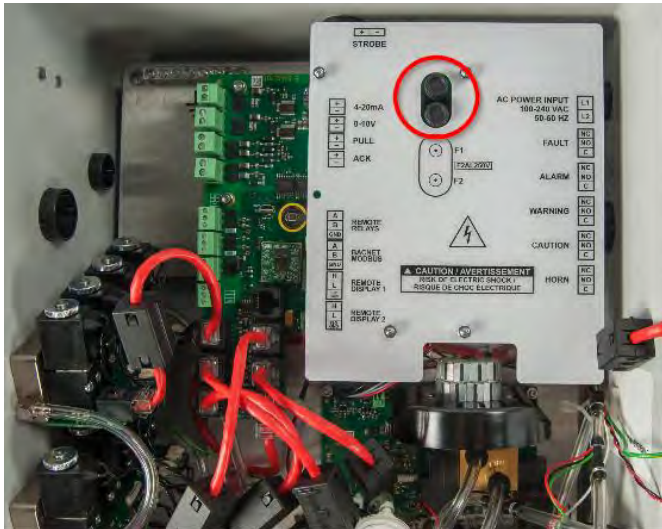

Fig. 16 Location of fuses

For a list of approved parts and how to order them, refer to Section 13 "Ordering Information". When necessary, do the following procedure to replace the fuses inside the device enclosure:

- (1) Disconnect electrical power to the device.
- (2) If applicable, remove the locking mechanism.
- (3) Release the two latches on the left side of the device.
- (4) Open the enclosure.
- (5) Attach the ESD wrist strap to the ESD connection point inside the enclosure.
- (6) Turn the top of the fuse holder counterclockwise and remove it.
- (7) Remove the defective fuse.
- (8) Install a new fuse. Only use MSA P/N 10185821 or an equivalent certified fuse.
- (9) Install the fuse holder and turn the top clockwise to secure it.
- (10) Disconnect the ESD wrist strap from the ESD connection point inside the enclosure.
- (11) Close the enclosure.
- (12) Latch the two latches.
- (13) If applicable, attach the locking mechanism.
- (14) Supply electrical power to the device.

## 10 Cleaning

### 10.1 Touchscreen Display

**NOTICE**

Use of improper cleaning materials can result in optical impairment of the display and/or damage to the device.

---

Use a soft lint-free cloth. The cloth can be dry or lightly dampened with a mild detergent. The detergent must have neutral pH. Do not use acidic or alkaline cleaners, or organic chemicals such as paint thinner, acetone, toluene, xylene, propyl or isopropyl alcohol, or kerosene.

### 10.2 Enclosure

Use a soft lint-free cloth. The cloth can be dry or lightly dampened with a mild detergent.

## 11 Technical Data

### 11.1 Technical Specifications / Equipment Ratings

Usage	Indoor use only	
Overvoltage	Category II	
Pollution	Degree 2	
ac Power	100–240 Vac, 50/60 Hz, 200 VA maximum Supply voltage not to fluctuate more than ±10%	
Operating Temperature	32–122°F (0 to 50°C)	
Operating Altitude Limit	9762 ft (2975 m)	
Operating Humidity	0 to 95%, noncondensing	
Ingress Protection	IP54	
Size	Height x Width x Depth = 15.6 in. x 13.6 in. x 7.6 in. (39.6 cm x 34.5 cm x 19.3 cm)	
Weight	4 point unit = 14 lb (6.4 kg) 8 point unit = 15 lb (6.8 kg) 16 point = 17 lb (7.7 kg)	
Sensor Type	Photoacoustic Infrared	
Sample Line Tubing	¼ in. OD x 1/8 in. ID	Polyurethane (ether based) or metal with tubing
	6 mm OD x 4 mm ID	
	Stainless steel tubing	
	FEP-lined tubing for NH <sub>3</sub>	
Sample Line Length	Up to 400 ft (121 m) for optimum performance, will support up to 1200 ft (366 m)	
Gases Chillgard 5000	R11, R12, R22, R123, R134A, R401A, R404A, R407A, R407C, R407F, R410A, R422A, R422D, R427A, R507, R-513A, R-514A, R1233zd(E), R1234yf, R1234ze, R-125, R-143A, R-152A, R-21, R-23, R-32, R-218, R-227, R-236FA, R-424A, R-426A, R-427A, R-438A, R-448A, R-449A, R-452B, R-455A, R-507A, R-508B	
Chillgard 5000	NH <sub>3</sub>	
Measuring Range	0–1000 ppm	
Sensitivity (minimum detection)	1 ppm for all listed R-gases 10 ppm for NH <sub>3</sub>	
Accuracy (linearity)	0– 50 ppm ±1 ppm, 51–1000 ppm ±10% of reading 0-50 ppm ±5ppm; 51-1000 ppm ±10% of reading for NH <sub>3</sub>	

US

Sensor Response Time	90% of gas reading < 19 sec 90% of gas reading < 60 sec for NH3
Relays	5 Form C, 8A 250 Vac resistive SPDT
Audible Alarm	95 ±5 dB(A) at 24 in. (61 cm) maximum
Communication Outputs	4–20 mA sourcing, 250 Ohm load; 0–10 V, 2 K Ohm minimum load; RS485 Modbus RTU; RS-485 BACnet MS/TP
Approvals	CAN/CSA C22.2 No. 61010-1-12 UL 61010-1, 3rd edition IEC/EN 61010-1:2010 CE conform EN 14624 (for multi-gas unit)

### 11.2 Gas Reading Accuracy

Factory Calibrated gases are gases whose behaviors have been characterized and built in to the Chillgard 5000 Firmware.

Gases in the extended library have not been specifically characterized. For these gases, the Chillgard 5000 will extrapolate the selected gas' behavior based on calibration data and the behavior of R134a.

Gas	Gas Concentration	Gas Reading Accuracy
As factory calibrated:		
R-134A, R-404A, R-410A, R-123, R1233zd(E), R-514A	1–50 ppm 51–1000 ppm	±1 ppm ±10% of F.S.
As factory calibrated extended library:		
R-11, R-12, R-1234ze, R-22, R-407F, R-401A, R-407A, R-422A, R-422D, R-427A, R-507, R-1234yf, R513A	1–50 ppm	±3 ppm
R-125, R-143A, R-152A, R-21, R-23, R-32, R-218, R-227, R-236FA, R-424A, R-426-A, R-438A, R-448A, R-449A, R-452B, R-455A, R-507A, R-508B	51–1000 ppm	±30% of reading
Calibrated with target gas:		
all refrigerant gases	1–50 ppm 51–1000 ppm	±3 ppm ±10% of F.S.
Ammonia (NH <sub>3</sub> )	1-50 ppm 51-1000 ppm	± 3 ppm ± 10% of F.S.



## 12 Troubleshooting Guidelines

### **WARNING!**

To prevent electrostatic discharge (ESD), connect an ESD wrist strap to the ESD connection point inside the device enclosure before doing work inside the enclosure. ESD can cause damage to the device.

Do not touch the electronic circuit boards.

Disconnect ac power before opening the device enclosure. Failure to do so can result in electrical shock. Electrical shock can cause damage to the device and injury to personnel.

Failure to follow these warnings can result in serious bodily injury or death.

#### **Device will not turn on.**

- (1) Make sure ac power is supplied to the device.
- (2) Make sure ac power to the device is wired correctly.
- (3) Make sure there are no loose wires on the ac inlet terminal block.
- (4) Check fuses F1 and F2. Replace them if necessary.

#### **Optional strobe will not signal during an alarm event.**

- (1) Check the user settings for strobe activation. Refer to Section 7.8.2 "Gas Configuration".
- (2) Make sure the strobe wires are connected to the strobe connector.
- (3) Contact MSA Customer Service.

#### **Internal buzzer will not signal during an alarm event.**

- (1) Check the user settings for buzzer/horn activation. Refer to Section 7.8.2 "Gas Configuration".
- (2) Make sure the buzzer wires are connected to the buzzer connector.
- (3) Contact MSA Customer Service.

#### **Relays are not operating.**

- (1) Check the user settings for the relays. Refer to Section 7.8.4 "Relay Configuration".
- (2) Test the relay. Refer to Section 7.8.4 "Relay Configuration".
- (3) Contact MSA Customer Service.

#### **No analog communication output.**

- (1) Check the user settings for communications. Refer to Section 7.8.5 "Communications Output".
- (2) Make sure the wire connections are correct.
- (3) Contact MSA Customer Service.

#### **No digital communication output.**

- (1) Check the user settings for communications. Refer to Section 7.8.5 "Communications Output".
- (2) Make sure the wire connections are correct.
- (3) Contact MSA Customer Service.

## 13 Ordering Information

To order parts, go to [MSAsafety.com](http://MSAsafety.com) and contact a MSA representative from your region.

### 13.1 Replacement Parts

**⚠ WARNING!**

Use only genuine MSA replacement parts when performing any maintenance procedures provided in this manual. Failure to do so may seriously impair sensor and gas monitoring performance. Repair or alteration of the Chillgard 5000 Fixed Gas Detection Device, beyond the scope of these maintenance instructions or by anyone other than authorized MSA service personnel, could cause the product to fail to perform as designed and persons who rely on this product for their safety could sustain serious personal injury or loss of life.

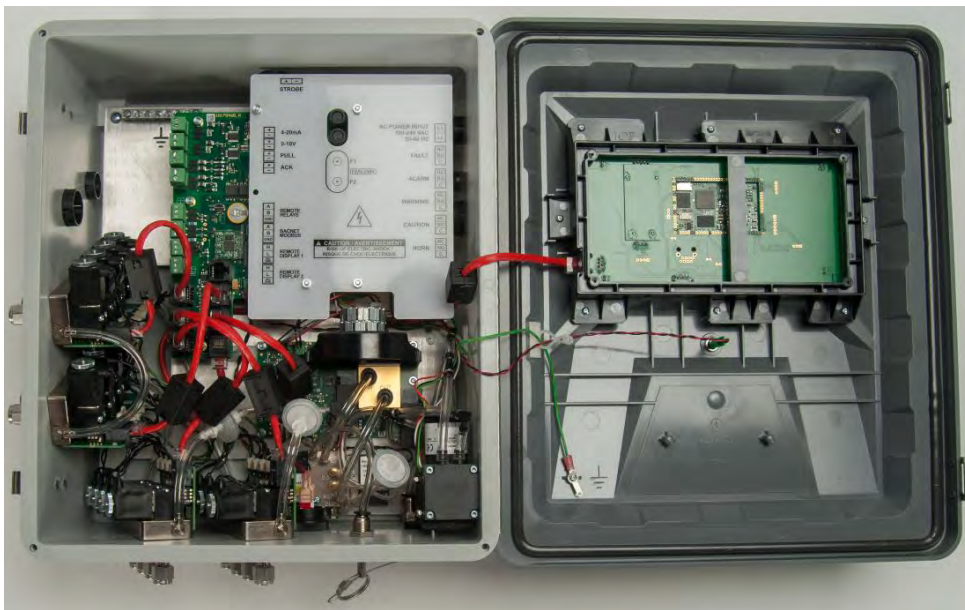

Fig. 17 Replacement Parts Identifier

**13.1.1 Replacement Parts**

<b>Description</b>	<b>Part Number</b>
Touchscreen Display Assembly	10186445
Sampling Valve Assembly	10186446
Sensor Module Assembly	10186447
Sensor Module Assembly NH <sub>3</sub>	10215298
Main Circuit Board Assembly	10186448
Pump Assembly Kit, Chillgard 5000	10190166
Pump Assembly Kit, Chillgard 5000 NH <sub>3</sub>	10215301
CAL/EQ, Valve Replacement Kit	10204293
Sample valve, repl, CG5000 NH <sub>3</sub>	10215299
Sample valve, repl, metric, CG5000 NH <sub>3</sub>	10215300
Bypass Manifold Kit, Chillgard 5000	10190167
Bypass Manifold Kit, Chillgard 5000 NH <sub>3</sub>	10215302
End of Line Filter Kit	711561
End of Line Filter NH <sub>3</sub>	711562
Internal Inline Filter	655533
Replacement Fuse Kit	10186428
Phoenix Terminal Kit	10186424

**13.1.2 Accessories**

<b>Description</b>	<b>Part Number</b>
External Alarm Silencing Station	10186427
External Alarm Activation Station	10186426
Remote Horn	10186435
Strobe	10058753
Maintenance Kit	10190345
Maintenance Kit NH <sub>3</sub>	10215309
SD card Chillgard 5000	10186441

## 13.1.3 Installation and Calibration

Description	Part Number
Polyurethane Tubing, 1/4 in. OD, 1/8 in. ID	10189778
Tubing, FEP 1/8" ID, 1/4" OD for NH <sub>3</sub>	603876
Internal Filter Kit	10190170
End of Line Filter Kit	10190169
End of Line Filter Kit NH <sub>3</sub>	10215303
Tubing Kit	10190168
Tubing Kit NH <sub>3</sub>	10215304
Smoke Tubes	458480
Zero Gas Scrubber	803873
Span Gas Scrubber	803874
Calibration Gas Regulator	710269
Calibration Gas Regulator NH <sub>3</sub>	10035594
Calibration Kit	10182184
Calibration Kit NH <sub>3</sub>	10215297
Field Upgrade Kit, 4 to 8 pt	10186443
Field Upgrade Kit, 4 to 8 pt NH <sub>3</sub>	10215305
Field Upgrade Kit, 8 to 16 pt	10186444
Field Upgrade Kit, 8 to 16 pt NH <sub>3</sub>	10215306
Field Upgrade Kit, 4 to 8 pt metric	10190172
Field Upgrade Kit, 4 to 8 pt NH <sub>3</sub> , metric	10215307
Field Upgrade Kit, 8 to 16 pt metric	10190173
Field Upgrade Kit, 8 to 16 pt NH <sub>3</sub> , metric	10215308



## 14 Appendix A: Start-up Check List

Before applying power to the Chillgard 5000, check for all items in the following table:

Item	Check for	Examiner's Initials
1	Proper mounting: <ul style="list-style-type: none"> <li>• Indoors on a rigid surface that does not have vibration or mechanical shock</li> <li>• In a vertical position approximately 5 ft (1.5 m) off the ground</li> <li>• Away from direct solar heating or other excessive heat sources, wet or damp conditions where condensation can occur, areas that are dirty or exposed to oils or chemicals, areas where explosive concentrations of combustible gases or vapors can occur</li> </ul>	
2	Correct electrical connections and wiring: <ul style="list-style-type: none"> <li>• Correct voltage: 100–240 Vac, 50/60 Hz, 200 VA maximum</li> <li>• Through a dedicated circuit breaker</li> <li>• Approved 3-conductor wire (minimum 16 AWG), rated 300 Vac at 221°F (105°C)</li> <li>• Conduit hubs and hardware that are suitable for fiberglass enclosures</li> </ul>	
3	Correct tubing for sample lines	
4	End-of-line filters installed in sample lines	
5	No end-of-line filter installed in exhaust line	
6	All caps and plugs at sample line inlets and exhaust port removed	
7	Unused sampling ports are disabled	
8	Correct calibration kit and check gases for calibration are available	
9	Proper exhaust venting to one of the following (outside atmosphere preferred): <ul style="list-style-type: none"> <li>• Outside atmosphere, end of exhaust tube protected from debris collection</li> <li>• Safe indoor area away from personnel and refrigerant gases</li> </ul>	

## 15 Appendix B: Installation of Optional Equipment

### **WARNING!**

Disconnect ac power before opening the device enclosure. Failure to do so can result in electrical shock. Electrical shock can cause damage to the device and injury to personnel.

To prevent electrostatic discharge (ESD), connect an ESD wrist strap to the ESD connection point inside the device enclosure before doing work inside the enclosure. ESD can cause damage to the device.

Do not touch the electronic circuit boards.

Failure to follow these warnings can result in serious bodily injury or death.

### 15.1 Strobe

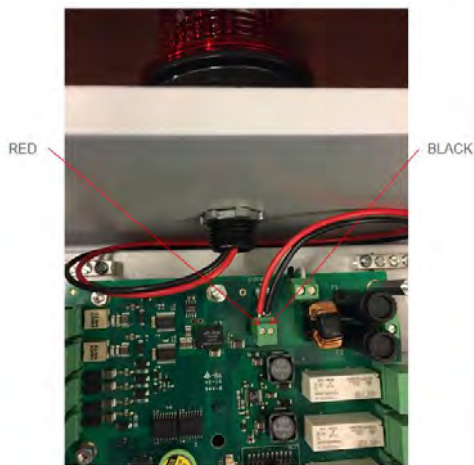

Fig. 18 Strobe wiring

For field installations, follow the strobe manufacturer's instructions and the following general procedure:

- (1) Disconnect electrical power to the device.
- (2) If applicable, remove the locking mechanism.
- (3) Release the two latches on the left side of the device.
- (4) Open the enclosure.
- (5) Attach the ESD wrist strap to the ESD connection point inside the enclosure.
- (6) Use a ¼-in. hex driver to remove the 4 hex nuts on the circuit board cover.
- (7) Remove the circuit board cover.
- (8) Remove the hole plug out of the top of the device.
- (9) Put the wires of the strobe through the middle of the supplied gasket.
- (10) Put the wires through the hole in the top of the enclosure and the supplied locknut.
- (11) Tighten the locknut so the strobe is attached securely to the device.

- (12) Insert the wires for the strobe into the Phoenix connector on the circuit board marked "STROBE". Make sure each wire is inserted into the correct connector terminal.
- (13) Use a small flathead screwdriver to tighten the screws on the Phoenix connector and secure the wires.
- (14) Install the circuit board cover.
- (15) Use a ¼-in. hex driver to install the 4 hex nuts on the circuit board cover.
- (16) Disconnect the ESD wrist strap from the ESD connection point inside the enclosure.
- (17) Close the enclosure.
- (18) Latch the two latches.
- (19) If applicable, attach the locking mechanism.
- (20) Supply electrical power to the device.

## 15.2 External Horn

For field installations, follow the horn manufacturer's instructions and the following general procedure:

- (1) Disconnect electrical power to the device.
- (2) If applicable, remove the locking mechanism.
- (3) Release the two latches on the left side of the device.
- (4) Open the enclosure.
- (5) Attach the ESD wrist strap to the ESD connection point inside the enclosure.
- (6) Mount the horn 7–12 ft (2–4 m) above the floor.
- (7) Use a ¼-in. hex driver to remove the 4 hex nuts on the circuit board cover.
- (8) Remove the circuit board cover.
- (9) Follow the wiring instructions supplied with the remote horn.
- (10) Insert the wires for the remote horn into the Phoenix connector marked "HORN" on the circuit board. Make sure each wire is inserted into the correct connector terminal:
  - a) For a normally de-energized relay, connect the wires to the "C" and "NO" terminals.
  - b) For a normally energized relay, connect the wires to the "C" and "NC" terminals.
- (11) Use a small flathead screwdriver to tighten the screws on the Phoenix connector and secure the wires.
- (12) Install the circuit board cover.
- (13) Use a ¼-in. hex driver to install the 4 hex nuts on the circuit board cover.
- (14) Disconnect the ESD wrist strap from the ESD connection point inside the enclosure.
- (15) Close the enclosure.
- (16) Latch the two latches.
- (17) If applicable, attach the locking mechanism.
- (18) Supply electrical power to the device.

### 15.3 External Alarm Activation Station

- (1) Disconnect electrical power to the device.
- (2) If applicable, remove the locking mechanism.
- (3) Release the two latches on the left side of the device.
- (4) Open the enclosure.
- (5) Attach the ESD wrist strap to the ESD connection point inside the enclosure.
- (6) Follow the wiring instructions supplied with the alarm activation station.
- (7) Insert the wires for the alarm activation station into the Phoenix connector marked "PULL" on the circuit board. Make sure the wires are inserted correctly.
- (8) Use a small flathead screwdriver to tighten the screws on the Phoenix connector and secure the wires.
- (9) Disconnect the ESD wrist strap from the ESD connection point inside the enclosure.
- (10) Close the enclosure.
- (11) Latch the two latches.
- (12) If applicable, attach the locking mechanism.
- (13) Supply electrical power to the device.

### 15.4 External Alarm Silencing Station

- (1) Disconnect electrical power to the device.
- (2) If applicable, remove the locking mechanism.
- (3) Release the two latches on the left side of the device.
- (4) Open the enclosure.
- (5) Attach the ESD wrist strap to the ESD connection point inside the enclosure.
- (6) Follow the wiring instructions supplied with the alarm silencing station.
- (7) Insert the wires for the alarm silencing station to the Phoenix connector marked "ACK" on the circuit board. Make sure each wire is inserted into the correct connector terminal.
- (8) Use a small flathead screwdriver to tighten the screws on the Phoenix connector and secure the wires.
- (9) Disconnect the ESD wrist strap from the ESD connection point inside the enclosure.
- (10) Close the enclosure.
- (11) Latch the two latches.
- (12) If applicable, attach the locking mechanism.
- (13) Supply electrical power to the device.

## 16 Appendix C: Default Settings

### 16.1 Alarm Setpoints

The default settings for the alarm setpoints are the following:

- 5, 20, and 50 percent of full-scale range, except for R123, which are 1, 2, and 5 percent of full-scale range
- Non-latching
- Horn and strobe (if applicable) enabled

### 16.2 Relays

The default setting for the internal fault relay is the energized state. All other relays (alarm, warning, caution, and horn) are set to de-energized.

### 16.3 Output

The default setting for digital output is None. The factory default settings for analog output are 3.5 mA for Warm-up and 2.0 mA for Fault.

## 17 Appendix D: Modbus Holding Registers

### 17.1 Chillgard 5000 - Modbus RTU (Holding Registers)

Section	Register Name	Channel #	Index	Property	Notes
General	Product ID	General	40001	Read	"CG"
	Firmware Version 1		40002	Read	Major(MSB:1b)/Minor(1b)
	Firmware Version 2		40003	Read	Build(2b)
	Reserved 4		40004	Read	0
	Reserved 5		40005	Read	0
	Reserved 6		40006	Read	0
	Unit Status		40007	Read	Refer to Section 17.3 "Unit Status Flags"
	ACK button		40008	Write	ACK by writing 1 to it
	RESET button		40009	Write	Refer to Section 17.2 "RESET Button Actions"
Channels	1 Gas Number	Channel 1	40010	Read	Refer to Section 17.5 "Gas Types"
	1 Gas Conc.		40011	Read	ppm
	1 Status		40012	Read	Refer to Section 17.4 "Channel Status Flags"
	1 Reserved		40013	Read	0
	2 Gas Number	Channel 2	40014	Read	Refer to Section 17.5 "Gas Types"
	2 Gas Conc.		40015	Read	ppm
	2 Status		40016	Read	Refer to Section 17.4 "Channel Status Flags"
	2 Reserved		40017	Read	0
	3 Gas Number	Channel 3	40018	Read	Refer to Section 17.5 "Gas Types"
	3 Gas Conc.		40019	Read	ppm
	3 Status		40020	Read	Refer to Section 17.4 "Channel Status Flags"
	3 Reserved		40021	Read	0
	4 Gas Number	Channel 4	40022	Read	Refer to Section 17.5 "Gas Types"
	4 Gas Conc.		40023	Read	ppm
	4 Status		40024	Read	Refer to Section 17.4 "Channel Status Flags"
	4 Reserved		40025	Read	0

Section	Register Name	Channel #	Index	Property	Notes
5	5 Gas Number	Channel 5	40026	Read	Refer to Section 17.5 "Gas Types"
	5 Gas Conc.		40027	Read	ppm
	5 Status		40028	Read	Refer to Section 17.4 "Channel Status Flags"
	5 Reserved		40029	Read	0
6	6 Gas Number	Channel 6	40030	Read	Refer to Section 17.5 "Gas Types"
	6 Gas Conc.		40031	Read	ppm
	6 Status		40032	Read	Refer to Section 17.4 "Channel Status Flags"
	6 Reserved		40033	Read	0
7	7 Gas Number	Channel 7	40034	Read	Refer to Section 17.5 "Gas Types"
	7 Gas Conc.		40035	Read	ppm
	7 Status		40036	Read	Refer to Section 17.4 "Channel Status Flags"
	7 Reserved		40037	Read	0
8	8 Gas Number	Channel 8	40038	Read	Refer to Section 17.5 "Gas Types"
	8 Gas Conc.		40039	Read	ppm
	8 Status		40040	Read	Refer to Section 17.4 "Channel Status Flags"
	8 Reserved		40041	Read	0
9	9 Gas Number	Channel 9	40042	Read	Refer to Section 17.5 "Gas Types"
	9 Gas Conc.		40043	Read	ppm
	9 Status		40044	Read	Refer to Section 17.4 "Channel Status Flags"
	9 Reserved		40045	Read	0
10	10 Gas Number	Channel 10	40046	Read	Refer to Section 17.5 "Gas Types"
	10 Gas Conc.		40047	Read	ppm
	10 Status		40048	Read	Refer to Section 17.4 "Channel Status Flags"
	10 Reserved		40049	Read	0
11	11 Gas Number	Channel 11	40050	Read	Refer to Section 17.5 "Gas Types"
	11 Gas Conc.		40051	Read	ppm
	11 Status		40052	Read	Refer to Section 17.4 "Channel Status Flags"
	11 Reserved		40053	Read	0



Section	Register Name	Channel #	Index	Property	Notes
	12 Gas Number	Channel 12	40054	Read	Refer to Section 17.5 "Gas Types"
	12 Gas Conc.		40055	Read	ppm
	12 Status		40056	Read	Refer to Section 17.4 "Channel Status Flags"
	12 Reserved		40057	Read	0
	13 Gas Number	Channel 13	40058	Read	Refer to Section 17.5 "Gas Types"
	13 Gas Conc.		40059	Read	ppm
	13 Status		40060	Read	Refer to Section 17.4 "Channel Status Flags"
	13 Reserved		40061	Read	0
	14 Gas Number	Channel 14	40062	Read	Refer to Section 17.5 "Gas Types"
	14 Gas Conc.		40063	Read	ppm
	14 Status		40064	Read	Refer to Section 17.4 "Channel Status Flags"
	14 Reserved		40065	Read	0
	15 Gas Number	Channel 15	40066	Read	Refer to Section 17.5 "Gas Types"
	15 Gas Conc.		40067	Read	ppm
	15 Status		40068	Read	Refer to Section 17.4 "Channel Status Flags"
	15 Reserved		40069	Read	0
	16 Gas Number	Channel 16	40070	Read	Refer to Section 17.5 "Gas Types"
	16 Gas Conc.		40071	Read	ppm
	16 Status		40072	Read	Refer to Section 17.4 "Channel Status Flags"
	16 Reserved		40073	Read	0



Section	Register Name	Channel #	Index	Property	Notes
Gases Calibration	Next Cal Time	Gases	40090	Read	In days from 1970
	Zero Cal Time		40091	Read	In days from 1970
	Span Cal Time #00		40092	Read	In days from 1970 – R-11
	Span Cal Time #01		40093	Read	In days from 1970 – R-12
	Span Cal Time #02		40094	Read	In days from 1970 – R-22
	Span Cal Time #03		40095	Read	In days from 1970 – R-123
	Span Cal Time #04		40096	Read	In days from 1970 – R-134A
	Span Cal Time #05		40097	Read	In days from 1970 – R-401A
	Span Cal Time #06		40098	Read	In days from 1970 – R-404A
	Span Cal Time #07		40099	Read	In days from 1970 – R-407A
	Span Cal Time #08		40100	Read	In days from 1970 – R-407C
	Span Cal Time #09		40101	Read	In days from 1970 – R-407F
	Span Cal Time #10		40102	Read	In days from 1970 – R-410A
	Span Cal Time #11		40103	Read	In days from 1970 – R-422A
	Span Cal Time #12		40104	Read	In days from 1970 – R-422D
	Span Cal Time #13		40105	Read	In days from 1970 – R-427A
	Span Cal Time #14		40106	Read	In days from 1970 – R-507
	Span Cal Time #15		40107	Read	In days from 1970 – R-513A
	Span Cal Time #16		40108	Read	In days from 1970 – R-514A
Span Cal Time #17	40109	Read	In days from 1970 – R-1233zd(E)		
Span Cal Time #18	40110	Read	In days from 1970 – R-1234yf		
Span Cal Time #19	40111	Read	In days from 1970 – R-1234ze		

## 17.2 RESET Button Actions

HiByte	LoByte	Description
0	channel#	Reset channel-specific alarms, channel#1-#16 = 0..15
0	255	Reset all channel-specific alarms
1	channel#	Reset channel-specific faults, channel#1-#16 = 0..15
1	255	Reset all channels-specific faults
2	255	Reset common faults
3	255	Reset all alarms and all faults

**17.3 Unit Status Flags**

Bit	Description	
0x0001	Warm up	Set if warm-up time is pending
0x0002	Operating	Normal operating mode is set (after warm-up; not in calibration, fault, or alarm)
0x0004	Calibration	Set if calibration is in progress
0x0008	Fault	Set if failure is reported
0x0010	Alarm	Set if C/W/A level is achieved
0xFFE0	---	Reserved

**17.4 Channel Status Flags**

Bit	Description	
0x0001	Caution	Set if caution level is achieved
0x0002	Warning	Set if warning level is achieved
0x0004	Alarm	Set if alarm level is achieved
0x0008	Beacon	Set if C/W/A is set
0x0010	Horn	Set if any configured C/W/A is set and not acknowledged yet
0x0020	New	Set if any of C/W/A is set and not acknowledged yet
0x0040	Hold	Set if any of C/W/A is in hold state (acknowledged latching alarm below threshold)
0x0080	Fault	Set if failure is reported
0xFF00	---	Reserved

## 17.5 Gas Types

Value	Name
0	R-11
1	R-12
2	R-22
3	R-123
4	R-134A
5	R-401A
6	R-404A
7	R-407A
8	R-407C
9	R-407F
10	R-410A
11	R-422A
12	R-422D
13	R-427A
14	R-507
15	R-513A
16	R-514A
17	R-1233zd(E)
18	R-1234yf
19	R-1234ze
20	User Gas 1
21	User Gas 2
22	User Gas 3
23	User Gas 4
24	User Gas 5
25	User Gas 6
26	Ammonia
27	R-21
28	R-23
29	R-32
30	R-125
31	R-143A
32	R-152A
33	R-218
34	R-227
35	R-236FA
36	R-424A
37	R-426A
38	R-438A
39	R-448A
40	R-449A
41	R-452B
42	R-455A
43	R-508B

Gases

US

## 18 Appendix E: BACnet Objects

### 18.1 Chillgard 5000 - BACnet

Section	Object Name	Channel #	Object Type	Inst #	Prop-erty	Notes
General	Product ID	General	Analog Input	1	Read	"CG"
	Firmware Version		Analog Input	2	Read	Build(MSB:2b)/Major(1b)/Minor(1b)
	Reserved 4		Analog Input	4	Read	0
	Reserved 5		Analog Input	5	Read	0
	Reserved 6		Analog Input	6	Read	0
	Unit Status		Analog Input	7	Read	Refer to Section 18.3 "Unit Status Flags"
	ACK button		Analog Input	8	Write	ACK by writing 1 to it
	RESET button		Analog Input	9	Write	Refer to Section 18.2 "RESET Button Actions"
Channels	1 Gas Number	Channel 1	Analog Input	10	Read	Refer to Section 18.5 "Gas Types"
	1 Gas Conc.		Analog Input	11	Read	ppm
	1 Status		Analog Input	12	Read	Refer to Section 18.4 "Channel Status Flags"
	1 Reserved		Analog Input	13	Read	0
	2 Gas Number	Channel 2	Analog Input	14	Read	Refer to Section 18.5 "Gas Types"
	2 Gas Conc.		Analog Input	15	Read	ppm
	2 Status		Analog Input	16	Read	Refer to Section 18.4 "Channel Status Flags"
	2 Reserved		Analog Input	17	Read	0
	3 Gas Number	Channel 3	Analog Input	18	Read	Refer to Section 18.5 "Gas Types"
	3 Gas Conc.		Analog Input	19	Read	ppm
	3 Status		Analog Input	20	Read	Refer to Section 18.4 "Channel Status Flags"
	3 Reserved		Analog Input	21	Read	0
	4 Gas Number	Channel 4	Analog Input	22	Read	Refer to Section 18.5 "Gas Types"
	4 Gas Conc.		Analog Input	23	Read	ppm
	4 Status		Analog Input	24	Read	Refer to Section 18.4 "Channel Status Flags"
	4 Reserved		Analog Input	25	Read	0

US

Section	Object Name	Channel #	Object Type	Inst #	Property	Notes	
	5 Gas Number	Channel 5	Analog Input	26	Read	Refer to Section 18.5 "Gas Types"	
	5 Gas Conc.		Analog Input	27	Read		ppm
	5 Status		Analog Input	28	Read		Refer to Section 18.4 "Channel Status Flags"
	5 Reserved		Analog Input	29	Read		0
	6 Gas Number	Channel 6	Analog Input	30	Read	Refer to Section 18.5 "Gas Types"	
	6 Gas Conc.		Analog Input	31	Read		ppm
	6 Status		Analog Input	32	Read		Refer to Section 18.4 "Channel Status Flags"
	6 Reserved		Analog Input	33	Read		0
	7 Gas Number	Channel 7	Analog Input	34	Read	Refer to Section 18.5 "Gas Types"	
	7 Gas Conc.		Analog Input	35	Read		ppm
	7 Status		Analog Input	36	Read		Refer to Section 18.4 "Channel Status Flags"
	7 Reserved		Analog Input	37	Read		0
	8 Gas Number	Channel 8	Analog Input	38	Read	Refer to Section 18.5 "Gas Types"	
	8 Gas Conc.		Analog Input	39	Read		ppm
	8 Status		Analog Input	40	Read		Refer to Section 18.4 "Channel Status Flags"
	8 Reserved		Analog Input	41	Read		0
	9 Gas Number	Channel 9	Analog Input	42	Read	Refer to Section 18.5 "Gas Types"	
	9 Gas Conc.		Analog Input	43	Read		ppm
	9 Status		Analog Input	44	Read		Refer to Section 18.4 "Channel Status Flags"
	9 Reserved		Analog Input	45	Read		0
	10 Gas Number	Channel 10	Analog Input	46	Read	Refer to Section 18.5 "Gas Types"	
	10 Gas Conc.		Analog Input	47	Read		ppm
	10 Status		Analog Input	48	Read		Refer to Section 18.4 "Channel Status Flags"
	10 Reserved		Analog Input	49	Read		0



Section	Object Name	Channel #	Object Type	Inst #	Property	Notes	
	11 Gas Number	Channel 11	Analog Input	50	Read	Refer to Section 18.5 "Gas Types"	
	11 Gas Conc.		Analog Input	51	Read		ppm
	11 Status		Analog Input	52	Read		Refer to Section 18.4 "Channel Status Flags"
	11 Reserved		Analog Input	53	Read		0
	12 Gas Number	Channel 12	Analog Input	54	Read	Refer to Section 18.5 "Gas Types"	
	12 Gas Conc.		Analog Input	55	Read		ppm
	12 Status		Analog Input	56	Read		Refer to Section 18.4 "Channel Status Flags"
	12 Reserved		Analog Input	57	Read		0
	13 Gas Number	Channel 13	Analog Input	58	Read	Refer to Section 18.5 "Gas Types"	
	13 Gas Conc.		Analog Input	59	Read		ppm
	13 Status		Analog Input	60	Read		Refer to Section 18.4 "Channel Status Flags"
	13 Reserved		Analog Input	61	Read		0
	14 Gas Number	Channel 14	Analog Input	62	Read	Refer to Section 18.5 "Gas Types"	
	14 Gas Conc.		Analog Input	63	Read		ppm
	14 Status		Analog Input	64	Read		Refer to Section 18.4 "Channel Status Flags"
	14 Reserved		Analog Input	65	Read		0
	15 Gas Number	Channel 15	Analog Input	66	Read	Refer to Section 18.5 "Gas Types"	
	15 Gas Conc.		Analog Input	67	Read		ppm
	15 Status		Analog Input	68	Read		Refer to Section 18.4 "Channel Status Flags"
	15 Reserved		Analog Input	69	Read		0
	16 Gas Number	Channel 16	Analog Input	70	Read	Refer to Section 18.5 "Gas Types"	
	16 Gas Conc.		Analog Input	71	Read		ppm
	16 Status		Analog Input	72	Read		Refer to Section 18.4 "Channel Status Flags"
	16 Reserved		Analog Input	73	Read		0



Section	Object Name	Channel #	Object Type	Inst #	Prop-erty	Notes
Gases Calibration	Next Cal Time	Gases	Analog Input	90	Read	In days from 1970
	Zero Cal Time		Analog Input	91	Read	In days from 1970
	Span Cal Time #00		Analog Input	92	Read	In days from 1970 – R-11
	Span Cal Time #01		Analog Input	93	Read	In days from 1970 – R-12
	Span Cal Time #02		Analog Input	94	Read	In days from 1970 – R-22
	Span Cal Time #03		Analog Input	95	Read	In days from 1970 – R-123
	Span Cal Time #04		Analog Input	96	Read	In days from 1970 – R-134A
	Span Cal Time #05		Analog Input	97	Read	In days from 1970 – R-401A
	Span Cal Time #06		Analog Input	98	Read	In days from 1970 – R-404A
	Span Cal Time #07		Analog Input	99	Read	In days from 1970 – R-407A
	Span Cal Time #08		Analog Input	100	Read	In days from 1970 – R-407C
	Span Cal Time #09		Analog Input	101	Read	In days from 1970 – R-407F
	Span Cal Time #10		Analog Input	102	Read	In days from 1970 – R-410A
	Span Cal Time #11		Analog Input	103	Read	In days from 1970 – R-422A
	Span Cal Time #12		Analog Input	104	Read	In days from 1970 – R-422D
	Span Cal Time #13		Analog Input	105	Read	In days from 1970 – R-427A
	Span Cal Time #14		Analog Input	106	Read	In days from 1970 – R-507
	Span Cal Time #15		Analog Input	107	Read	In days from 1970 – R-513A
	Span Cal Time #16		Analog Input	108	Read	In days from 1970 – R-514A
Span Cal Time #17	Analog Input	109	Read	In days from 1970 – R-1233zd(E)		
Span Cal Time #18	Analog Input	110	Read	In days from 1970 – R-1234yf		
Span Cal Time #19	Analog Input	111	Read	In days from 1970 – R-1234ze		

US

**18.2 RESET Button Actions**

HiByte	LoByte	Description
0	channel#	Reset channel-specific alarms, channel#1-#16 = 0..15
0	255	Reset all channel-specific alarms
1	channel#	Reset channel-specific faults, channel#1-#16 = 0..15
1	255	Reset all channels-specific faults
2	255	Reset common faults
3	255	Reset all alarms and all faults

**18.3 Unit Status Flags**

Bit	Description
0x0001	Warm up Set if warm-up time is pending
0x0002	Operating Normal operating mode is set (after warm-up; not in calibration, fault, or alarm)
0x0004	Calibration Set if calibration is in progress
0x0008	Fault Set if failure is reported
0x0010	Alarm Set if C/W/A level is achieved
0xFFE0	--- Reserved

**18.4 Channel Status Flags**

Bit	Description
0x0001	Caution Set if caution level is achieved
0x0002	Warning Set if warning level is achieved
0x0004	Alarm Set if alarm level is achieved
0x0008	Beacon Set if C/W/A is set
0x0010	Horn Set if any configured C/W/A is set and not acknowledged yet
0x0020	New Set if any of C/W/A is set and not acknowledged yet
0x0040	Hold Set if any of C/W/A is in hold state (acknowledged latching alarm below threshold)
0x0080	Fault Set if failure is reported
0xFF00	--- Reserved



## 18.5 Gas Types

Value	Name
0	R-11
1	R-12
2	R-22
3	R-123
4	R-134A
5	R-401A
6	R-404A
7	R-407A
8	R-407C
9	R-407F
10	R-410A
11	R-422A
12	R-422D
13	R-427A
14	R-507
15	R-513A
16	R-514A
17	R-1233zd(E)
18	R-1234yf
19	R-1234ze
20	User Gas 1
21	User Gas 2
22	User Gas 3
23	User Gas 4
24	User Gas 5
25	User Gas 6
26	Ammonia
27	R-21
28	R-23
29	R-32
30	R-125
31	R-143A
32	R-152A
33	R-218
34	R-227
35	R-236FA
36	R-424A
37	R-426A
38	R-438A
39	R-448A
40	R-449A
41	R-452B
42	R-455A
43	R-508B

Gases

US

